

Ured: Ulica Andrije Kačića Miošića 22
10 000 Zagreb
Tel: +385 (1) 30 20 444
Fax: +385 (1) 30 20 445
E-mail: radionica@statika.hr
MB: 2274167
OIB: 21520453993
IBAN: HR1523600001101986157



**RADIONICA
STATIKE**

INVESTITOR: HRVATSKI CRVENI KRIŽ
Ulica Crvenog križa 14-16
10 000 Zagreb
OIB: 72527253659

GRAĐEVINA: ZGRADA CENTRA
HRVATSKOG CRVENOG
KRIŽA ZA KORISNIKE
SOCIJALNIH USLUGA U
ZAJEDNICI

LOKACIJA: Zagreb, Dubravkin trg 11
k.č.br. 277, k.o. Trnje

RAZINA: IZVEDBENI PROJEKT

T.D.: 135/2020

Z.O.P.: 993/20

MAPA



GRAĐEVINSKI PROJEKT

PROJEKT KONSTRUKCIJE – NACRTI ARMATURE

GLAVNI
PROJEKTANT:

Sanela Beganović, dipl.ing.arh.
(A 2203)

elektronički potpis

PROJEKTANT
KONSTRUKCIJE:

Branko Galić, dipl.ing.građ.
(G 3065)

elektronički potpis

SURADNICI:

Vlaho Miljanović, mag.ing.aedif.

Toma Ćurković, mag.ing.aedif.

Lara Antulov-Fantulin, mag.ing.aedif.

DIREKTOR:

Branko Galić, dipl.ing.građ.

DONJA ZONA

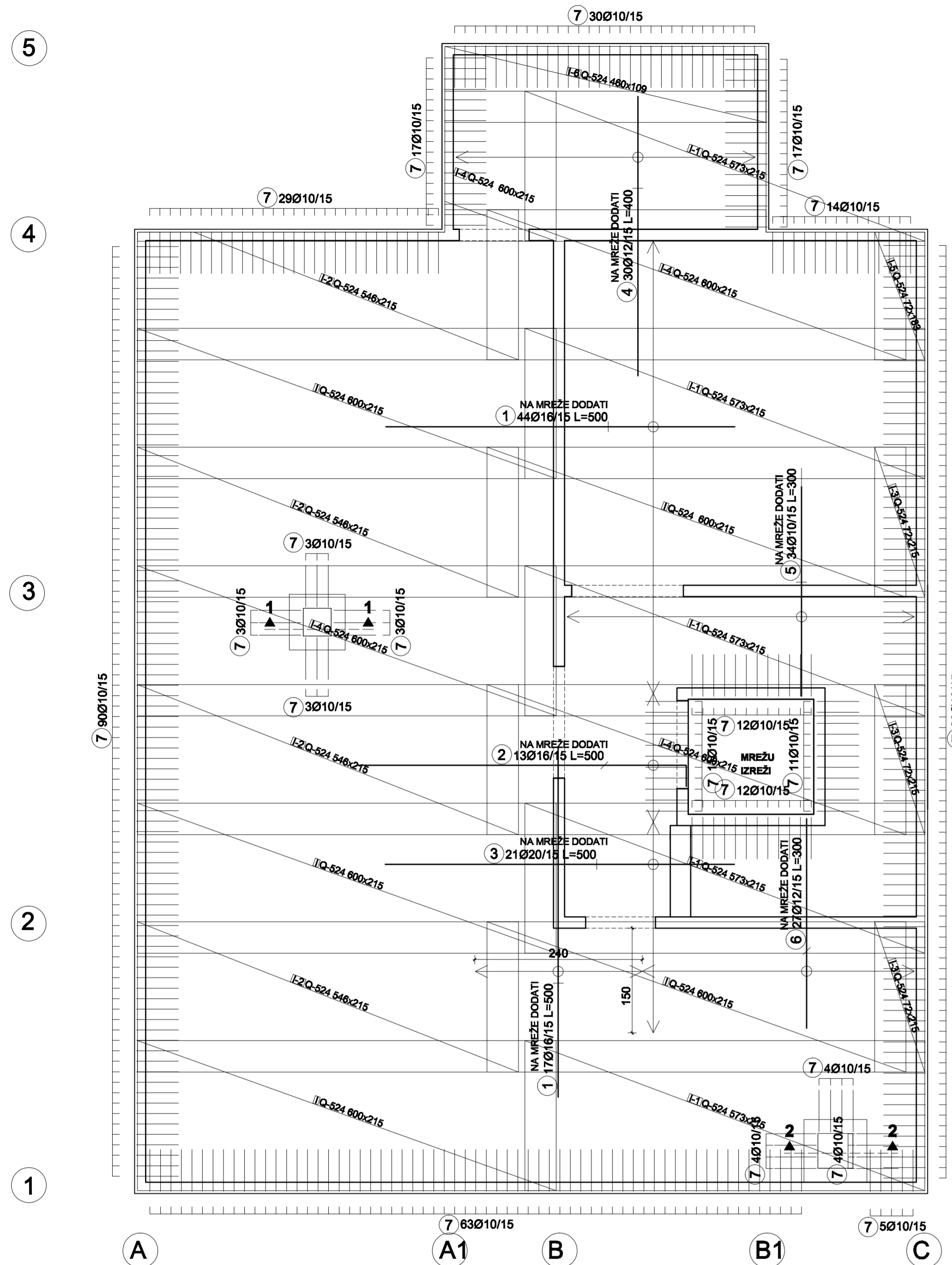

NASTAVCI

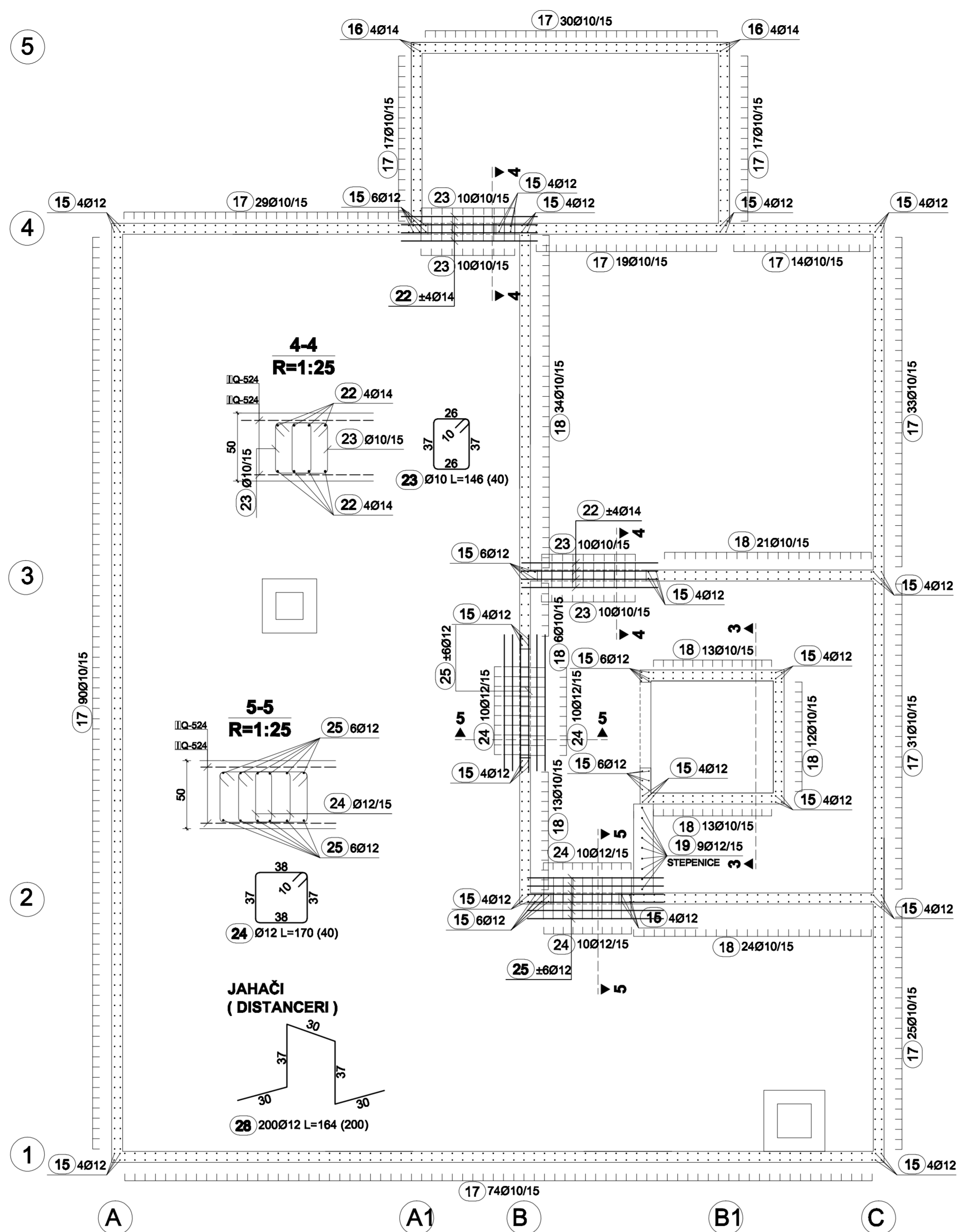

GORNJA ZONA

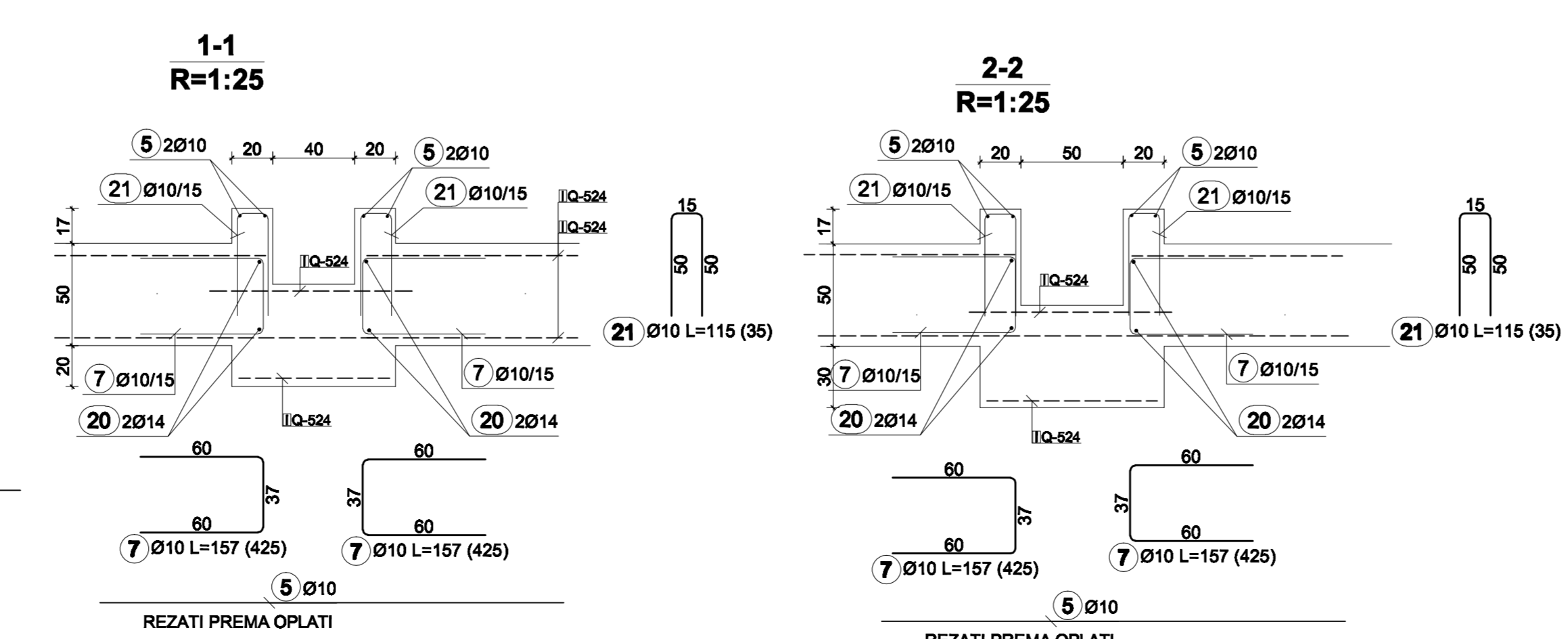
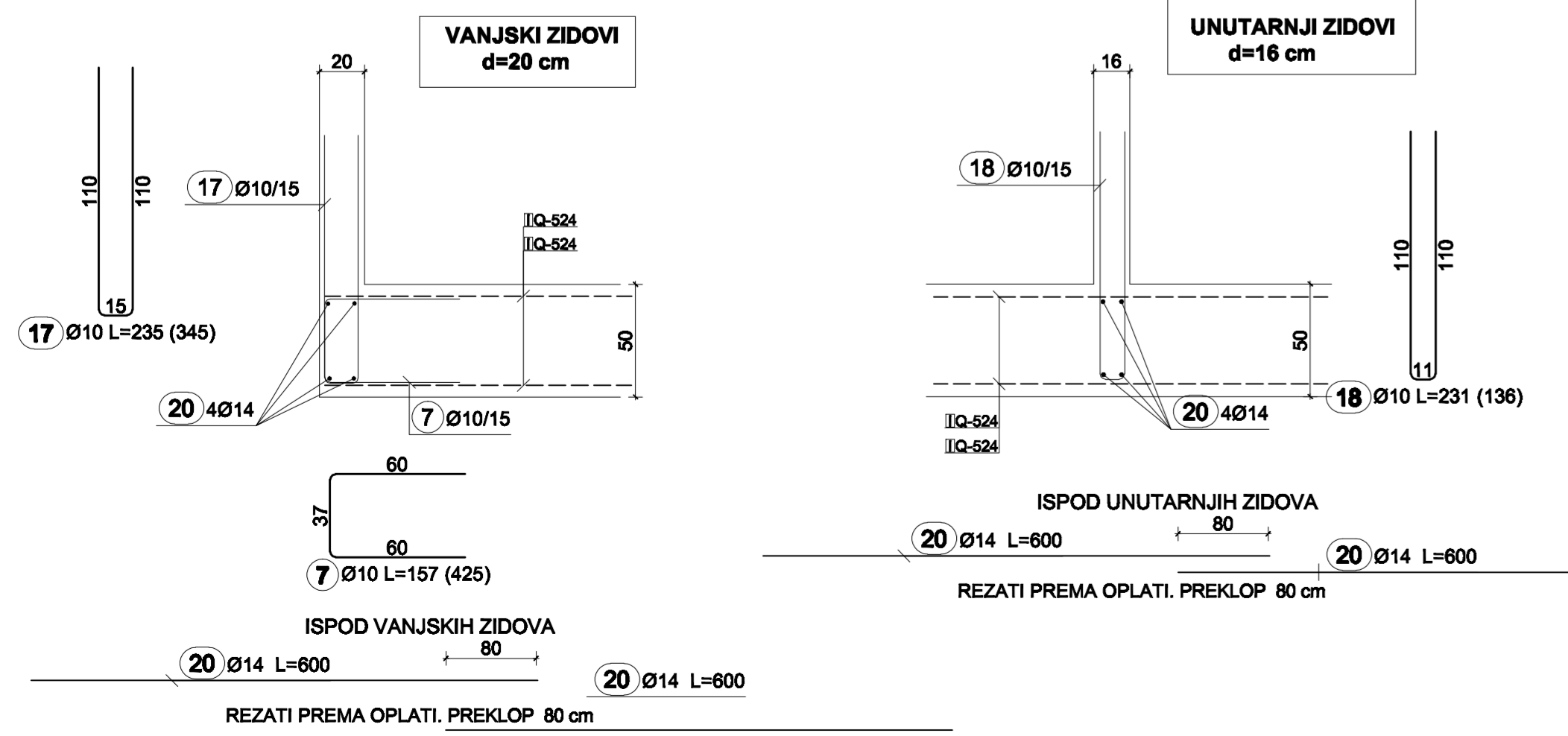
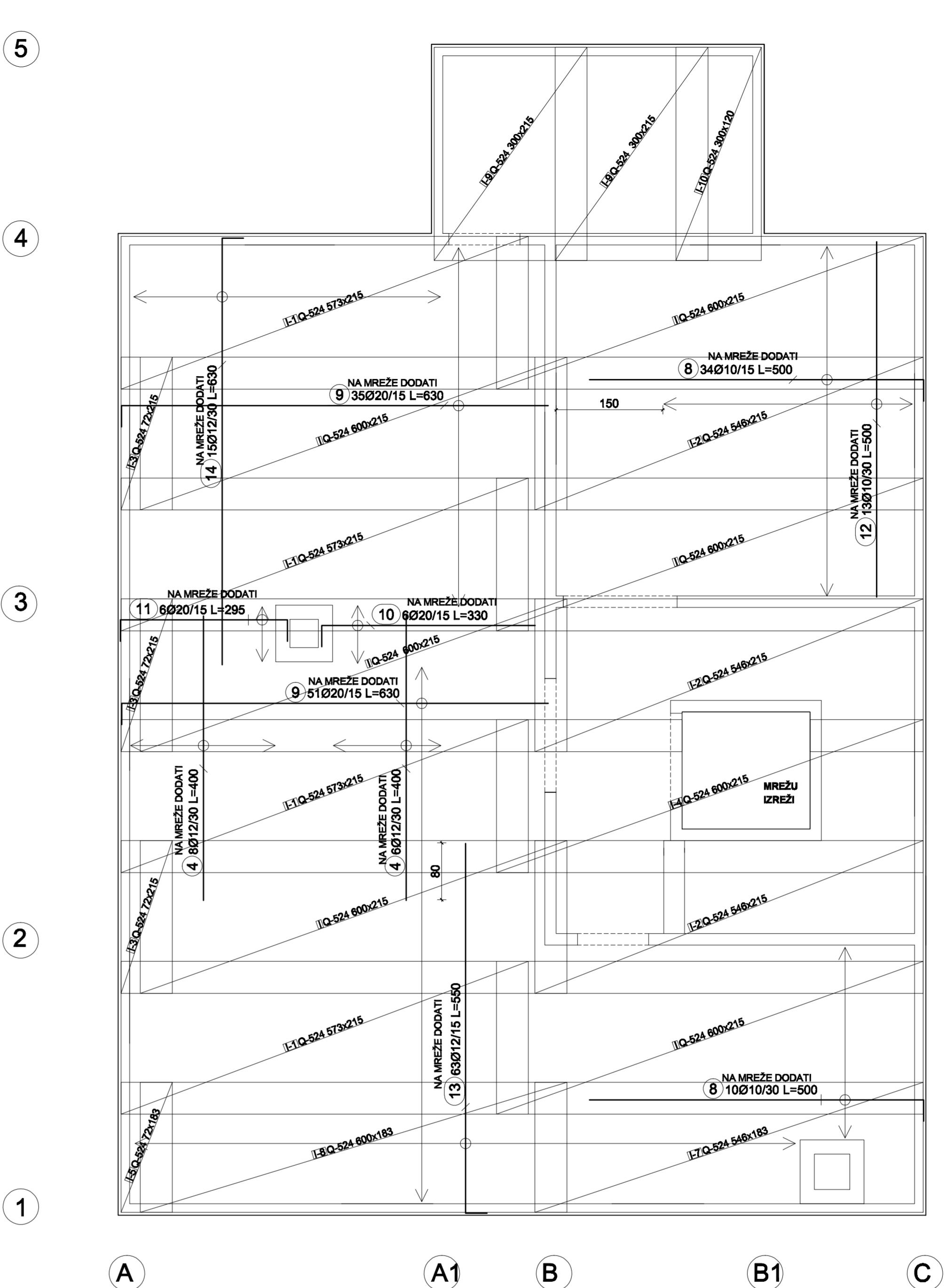

Šifra - specifikacija	odm. i mjere [cm]	oznaka (i kanti)	Ø [mm]	lg [m]	n [kom]	lg [m]
1	800		16	6.00	61	306.00
2	470		16	6.00	13	65.00
3	800		20	6.00	21	100.00
4	400		12	4.00	44	176.00
5	800		10	3.00	40	120.00
6	800		12	3.00	27	81.00
7	60		10	1.87	426	687.30
8	470		16	6.00	44	220.00
9	800		20	6.30	66	541.80
10	300		20	2.30	6	19.80
11	300		20	2.85	6	17.70
12	800		10	6.00	13	65.00
13	800		12	5.50	63	346.50
14	800		12	6.30	15	94.50
15	25		12	1.45	66	142.10
16	140		14	1.65	8	12.40
17	110		10	2.30	340	610.70
18	110		10	2.31	136	244.16
19	100		12	1.65	9	14.85
20	600		14	6.00	66	396.00
21	60		10	1.15	35	40.25
22	300		14	2.00	16	32.00
23	60		10	1.48	40	66.40
24	60		12	1.70	40	68.00
25	300		12	2.30	24	48.00
26	60		10	1.28	32	40.96
28	60		12	1.64	200	328.00

Ø [mm]	lg [m]	Jedinična težina [kg/m]	Težina [kg]
10	2306.77	0.62	1441.79
12	1206.60	0.89	1183.47
14	440.40	1.21	532.88
16	370.00	1.58	564.80
20	684.30	2.47	1689.22
Ukupno			5402.96

Ø-S24	Ø	L [m]	n	Jedinična težina [kg/m²]	Ukupna težina [kg]
Q-S24	210	600	37	8.22	3622.41
Ukupno					3622.41

TEMELJNA PLOČA

Br. revizije: REVIZIJA Datum revizije:

RADIONICA STATIKE d.o.o. INVESTITOR: HRVATSKO CRKVENI VEŠTAČKI IZVODNI VEŠTAČKI IZ OBLASTI GRAĐEVINARSTVA I INŽINJERINGA

PROJEKTANT: *Branislav Galić* GRAĐEVINAR: ZGRADA CENTRA HRVATSKOG CRKVENOG VEŠTAČKI IZVODNI VEŠTAČKI IZ OBLASTI GRAĐEVINARSTVA I INŽINJERINGA

KONSTRUKCIJE: *Branislav Galić* LOKACIJA: Zagreb, Šibenička ulica 11 I. s. p. 27.1.15. Trg

FAZA PROJEKTA: IZVEDBENI GRAĐEVINSKI PROJEKT

SURADNICI: Vlaho Mijanović, mag.ing.aedif. SARUŽA: TEMELJNA PLOČA

Tomislav Čurković, mag.ing.aedif. MJERILO: 1:50 DATUM: 02/2021

Lars Antunović-Fantulin, mag.ing.aedif. BR.PR.TD: 135/2020 BR.NACRTA: 1

PREKLOP MREŽA U OBA SMJERA a=45 cm

ZAŠITNI SLOJ BETONA c=4,0 cm

BETON C25/30 ARMATURA B500B

5

4

3

2

1

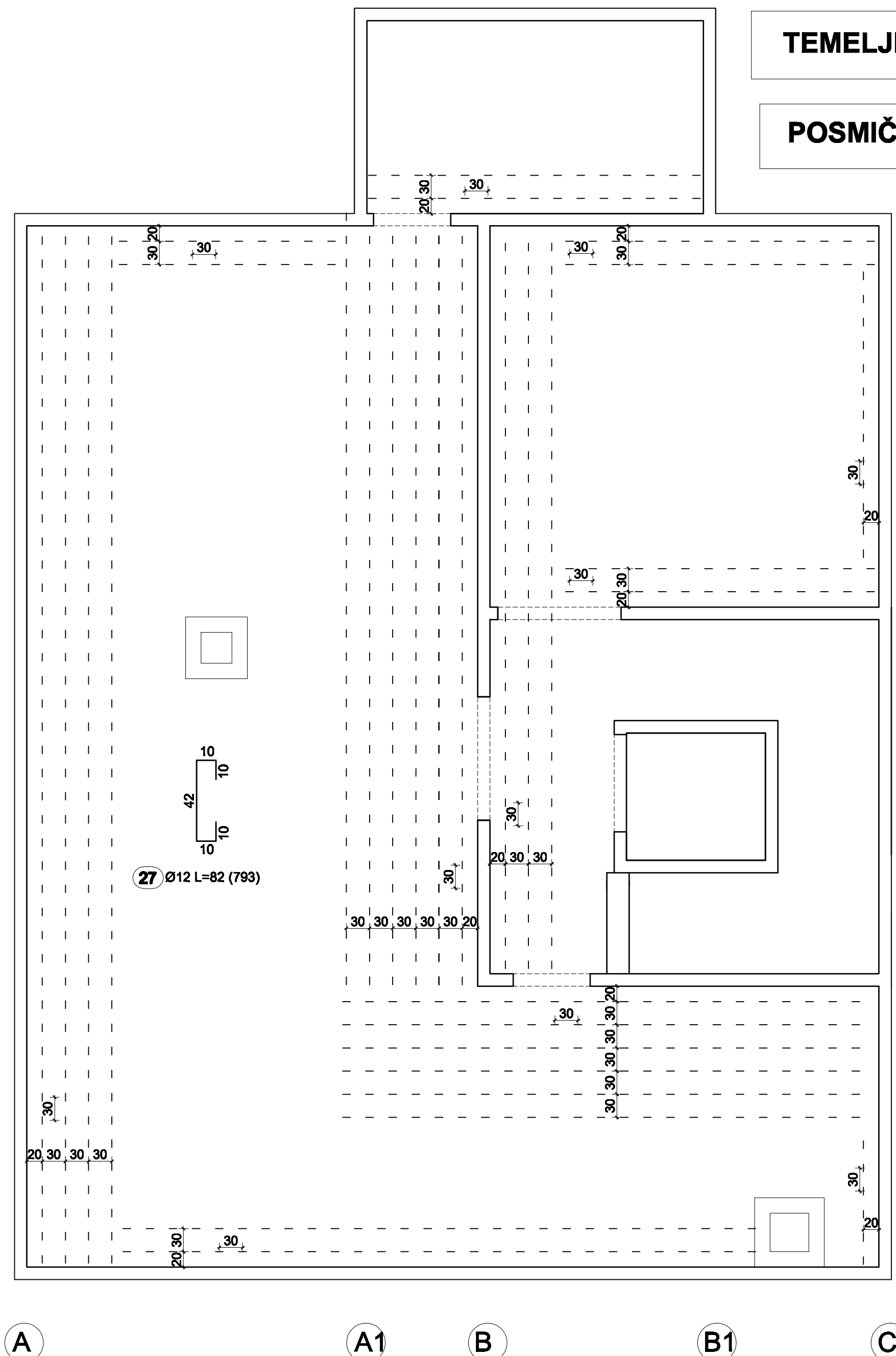

TEMELJNA PLOČA - d=50 cm

POSMIČNA ARMATURA

Šipke - specifikacija

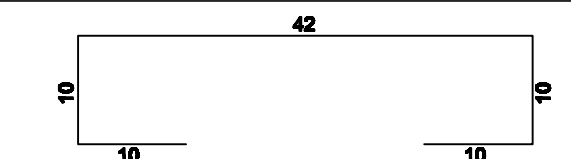
ozn	oblik i mjera [cm]	Ø	lg [m]	n [kom]	lg _n [m]
noname (1 kom)					
27		12	0.82	793	650.26

TEMELJNA PLOČA
POSMIČNA ARMATURA

NAPOMENA:
"VILICE" ST. 27 - NATAKNUTI PREKO ŠIPKI GORNJE
ARMATURE, A DOLJE ZAKVAČITI ZA ARMATURNU
MREŽU DONJE ZONE.

Br. revizije:	REVIZIJA	Datum revizije:	
 RADIONICA STATIKE d.o.o. <small>Andrija Kačić Miošića 22, 10 000 Zagreb tel: +385 (0)20 20 444 fax: +385 (0)20 20 444 e-mail: radionica@statika.hr</small>			
GLAVNI PROJEKTANT:	Sanela Beganović, dipl.ing.arh.	INVESTITOR:	HRVATSKI CRVENI KRIŽ
PROJEKTANT KONSTRUKCIJE:	Branko Galić, dipl.ing.grad. <i>B. Galić</i>	GRAĐEVINA:	ZGRADA CENTRA HRVATSKOG CRVENOG KRIŽA U KORISNIKESOCIJALNIH USLUGA U ZAJEDNICI
		LOKACIJA:	Zagreb, Dubravkin trg 11 k.č.br: 277, k.o. Trnje
		FAZA PROJEKTA:	IZVEDBENI GRAĐEVINSKI PROJEKT
SURADNICI:	Vlaho Miljanović, mag.ing.aedif.	SADRŽAJ:	TEMELJNA PLOČA - POSMIČNA ARMATURA
	Toma Čurković, mag.ing.aedif. Lara Antulov-Fantulin, mag.ing.aedif.	MJERILO:	1:50
		DATUM:	02/2021
		BR.PR.:TD	135/2020
		BR.NACRTA:	2

ZID OS - " 1 "

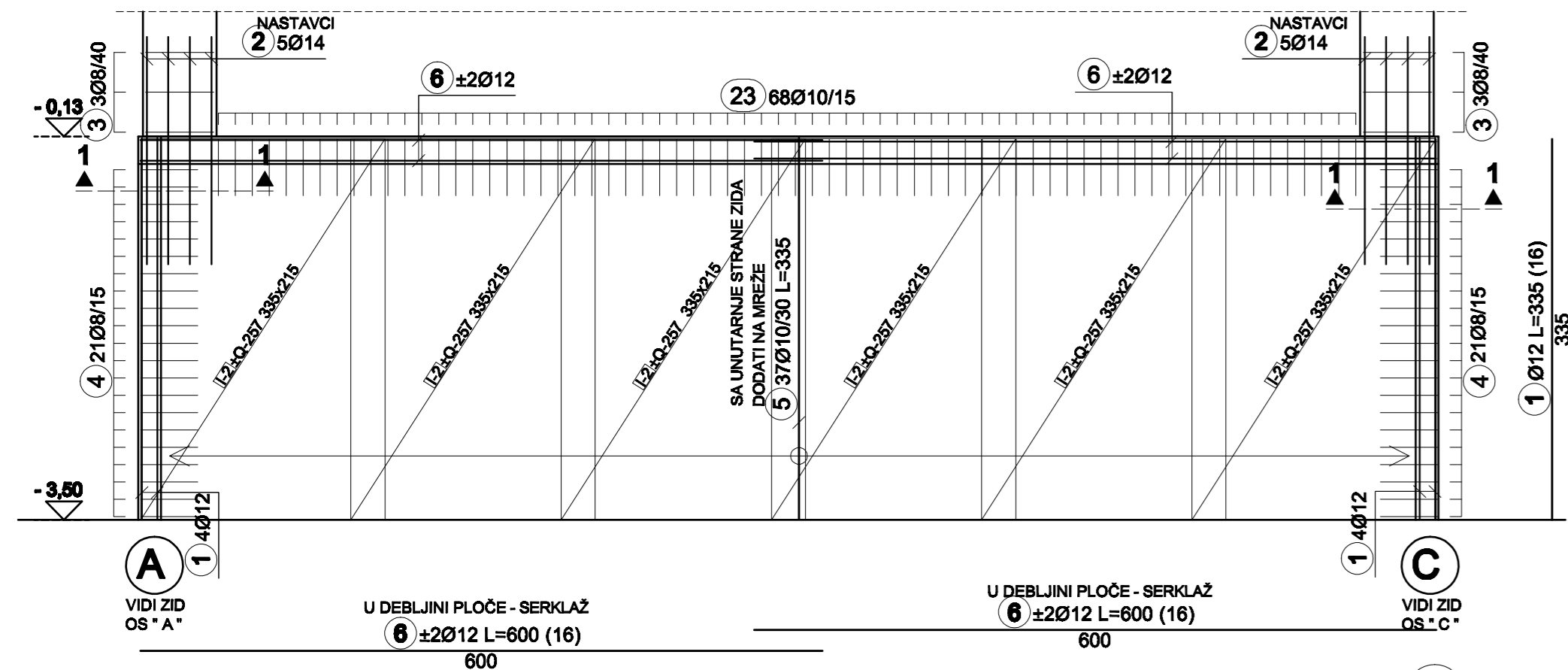

ZID OS - " 2 "

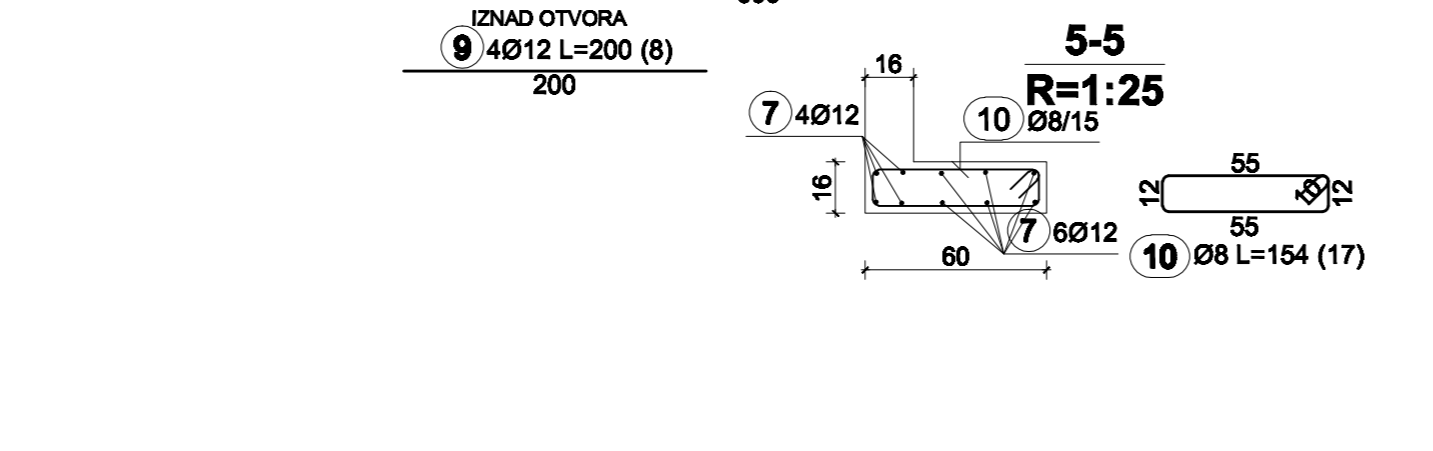
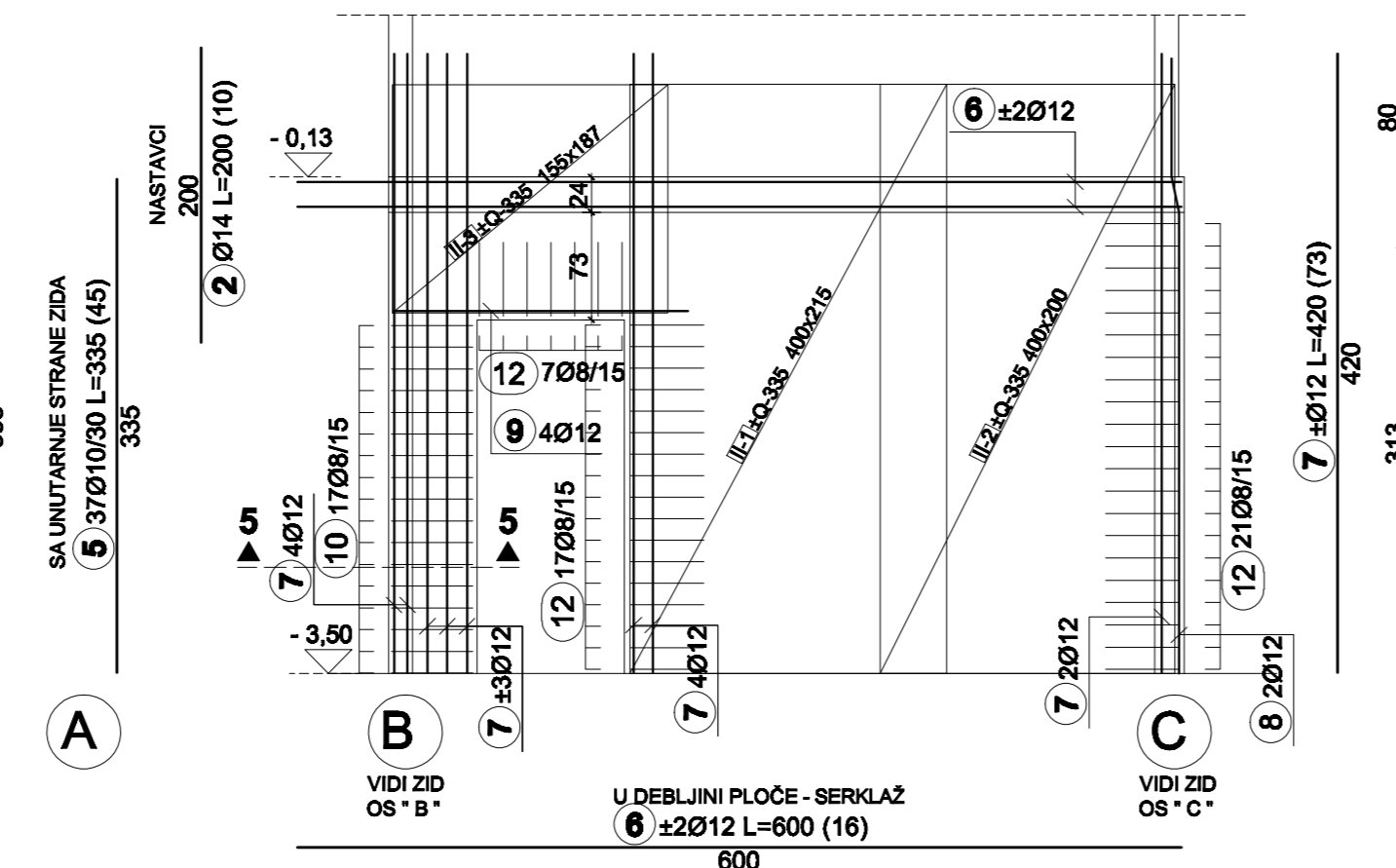

ZID OS - " 3 "

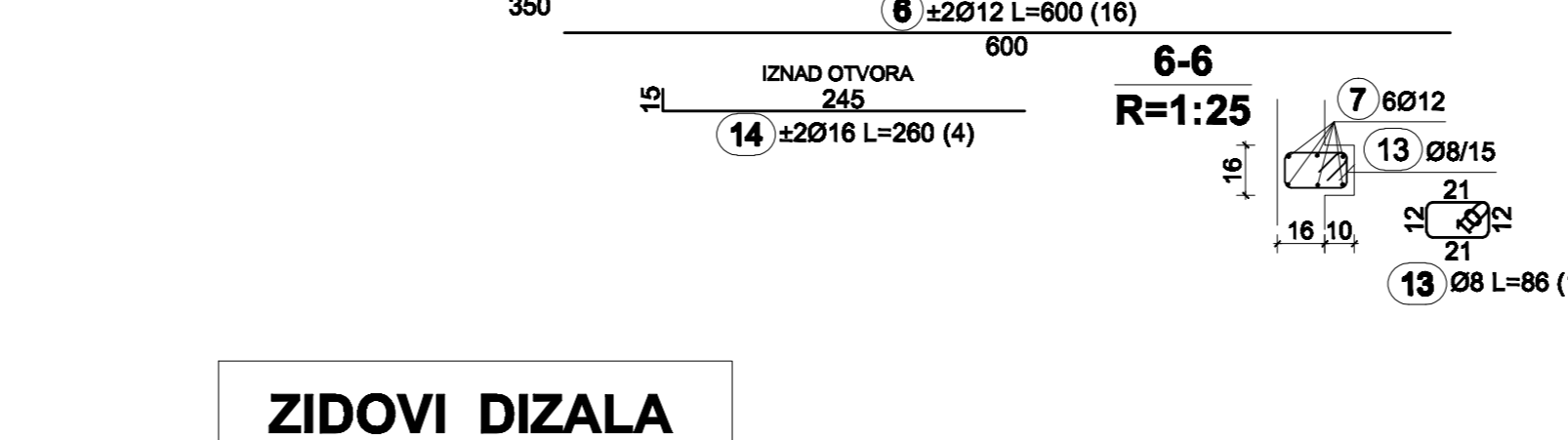
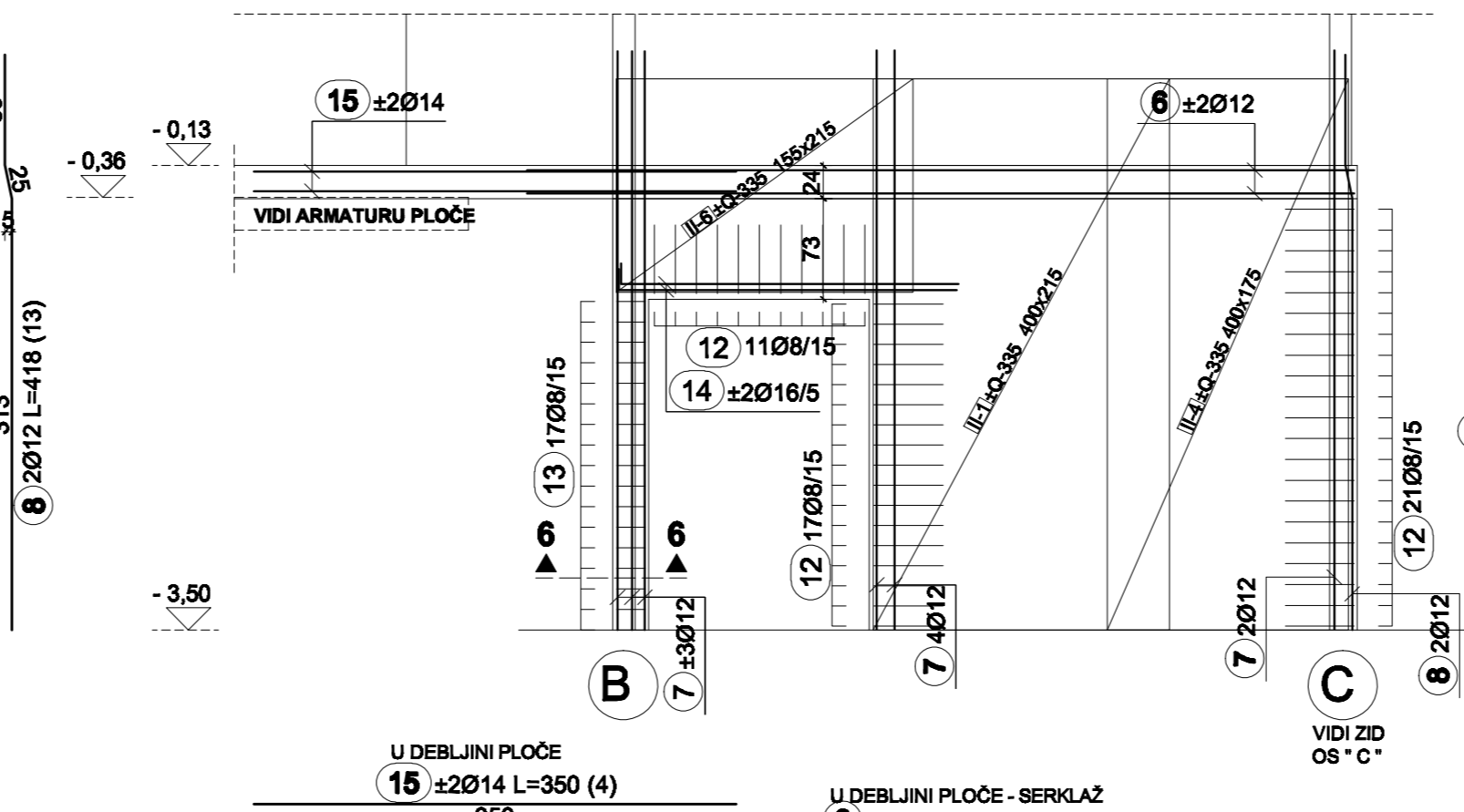

ZID OS - " 5 "

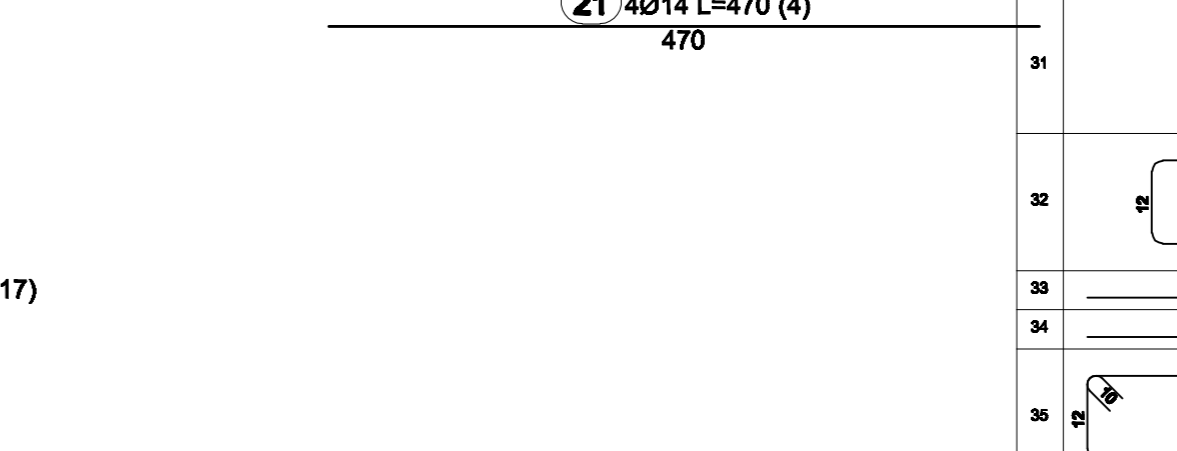
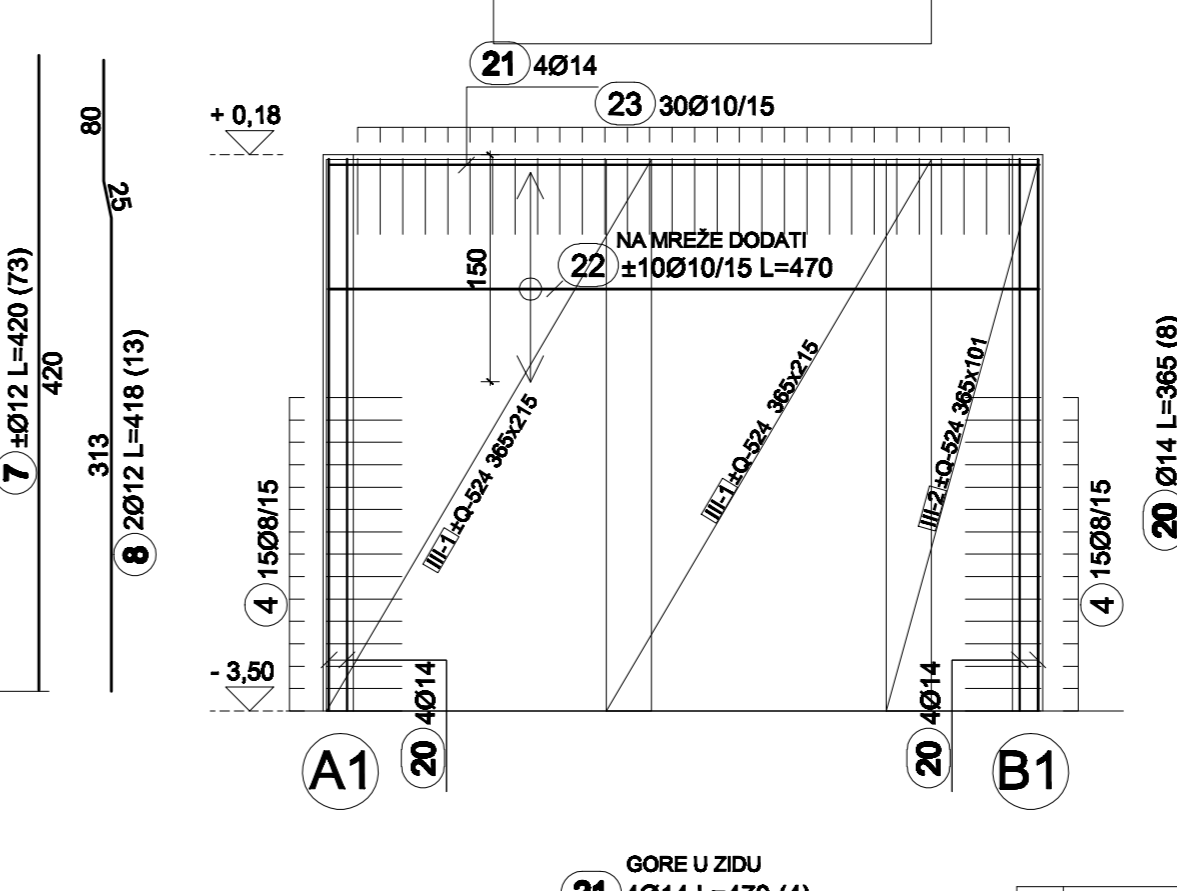

ZID OS - " 4 "

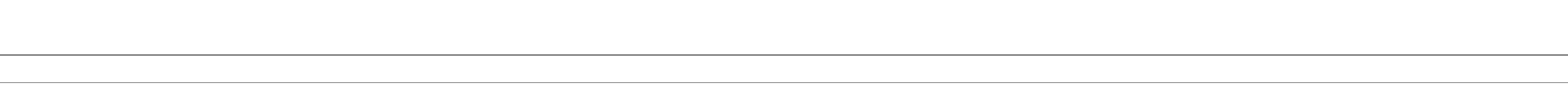
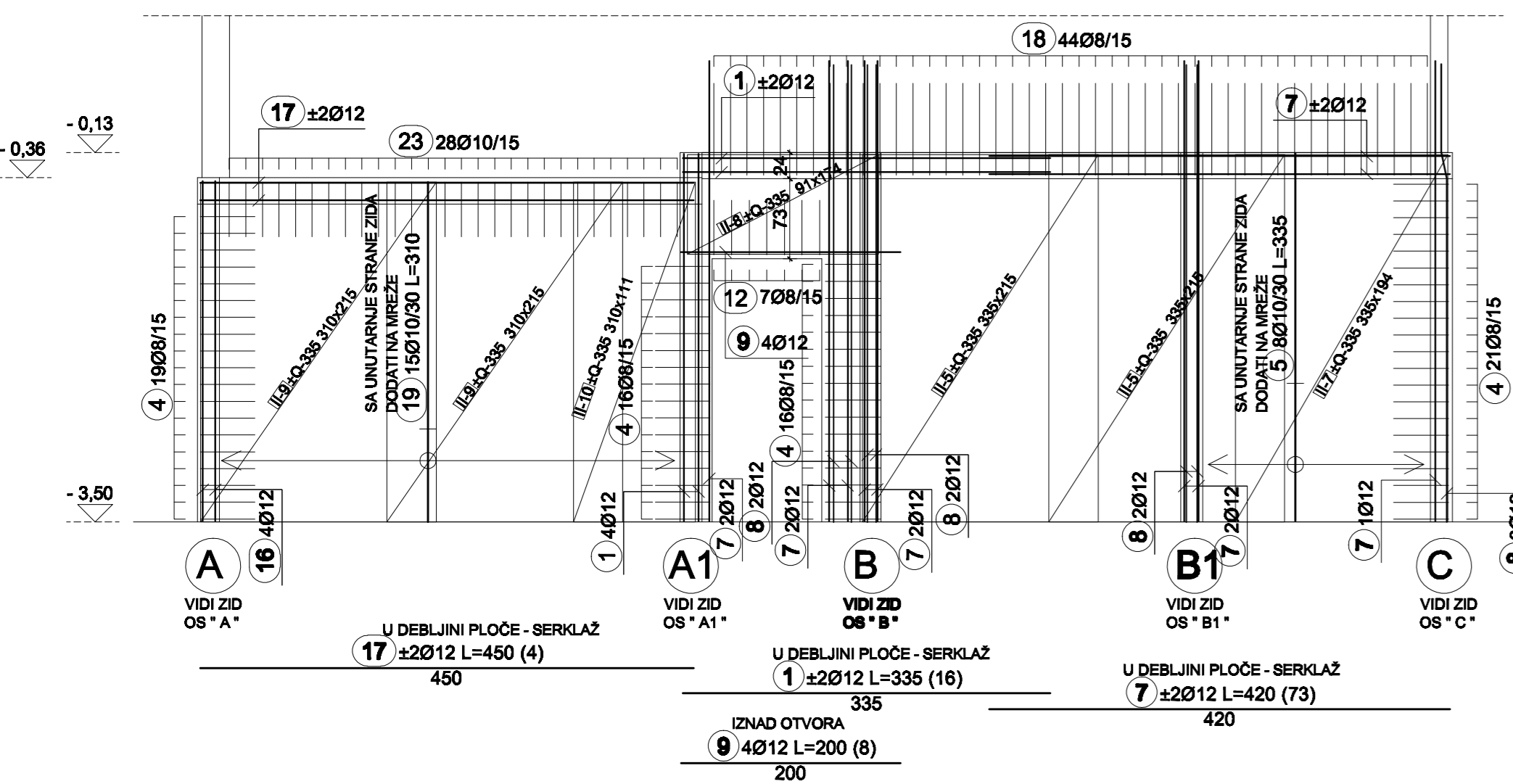

ZID OS - " Y7 "

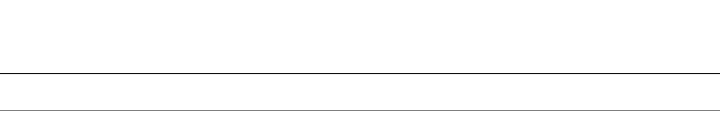
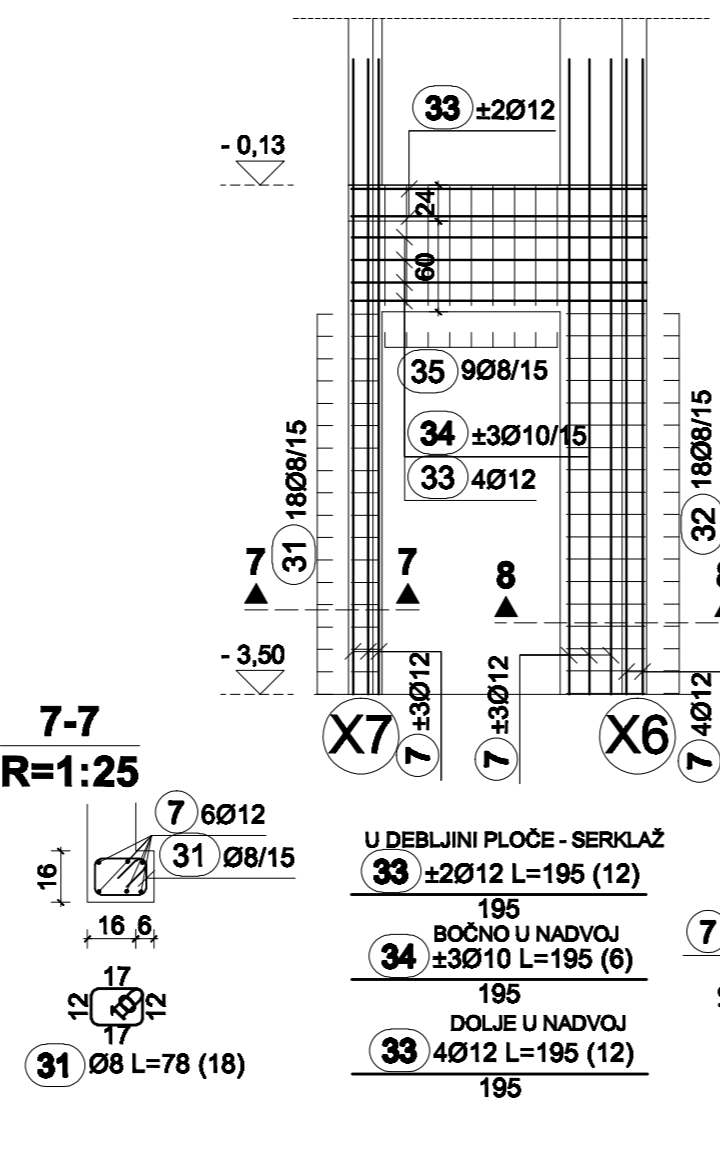

ZID OS - " Y6 "

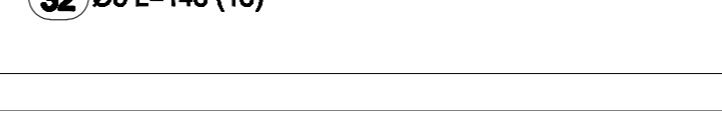
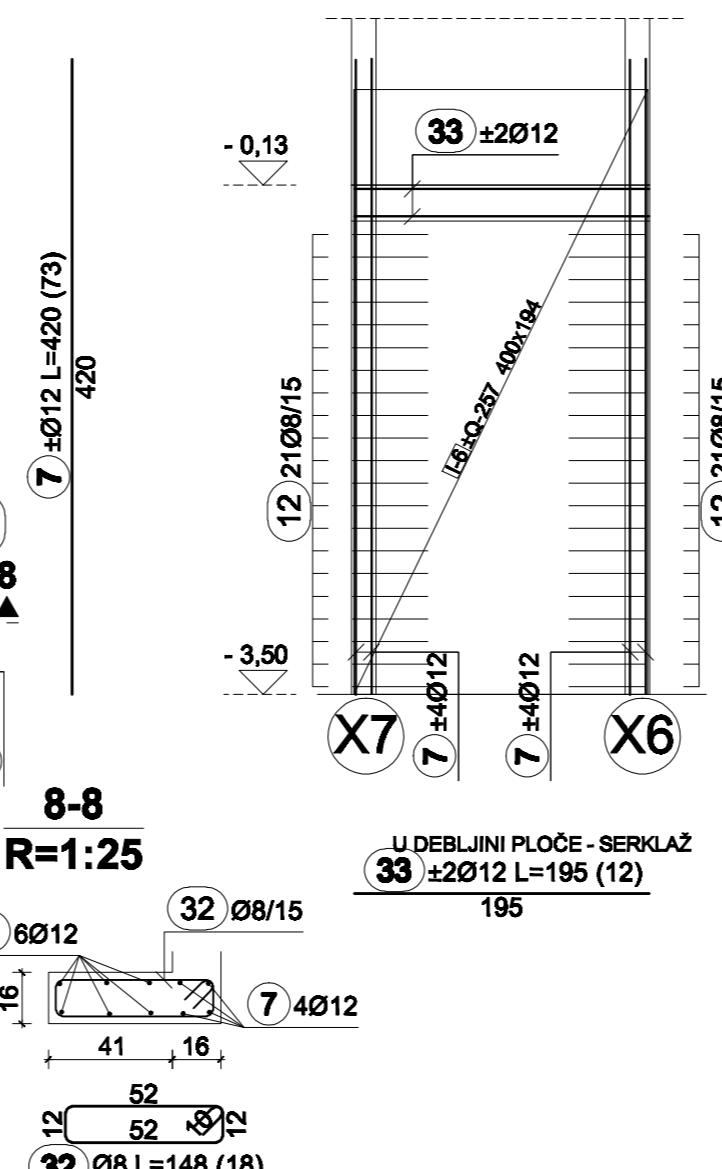

ZID OS - " X6 "

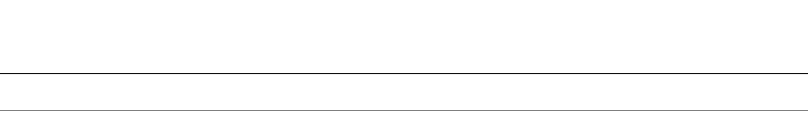
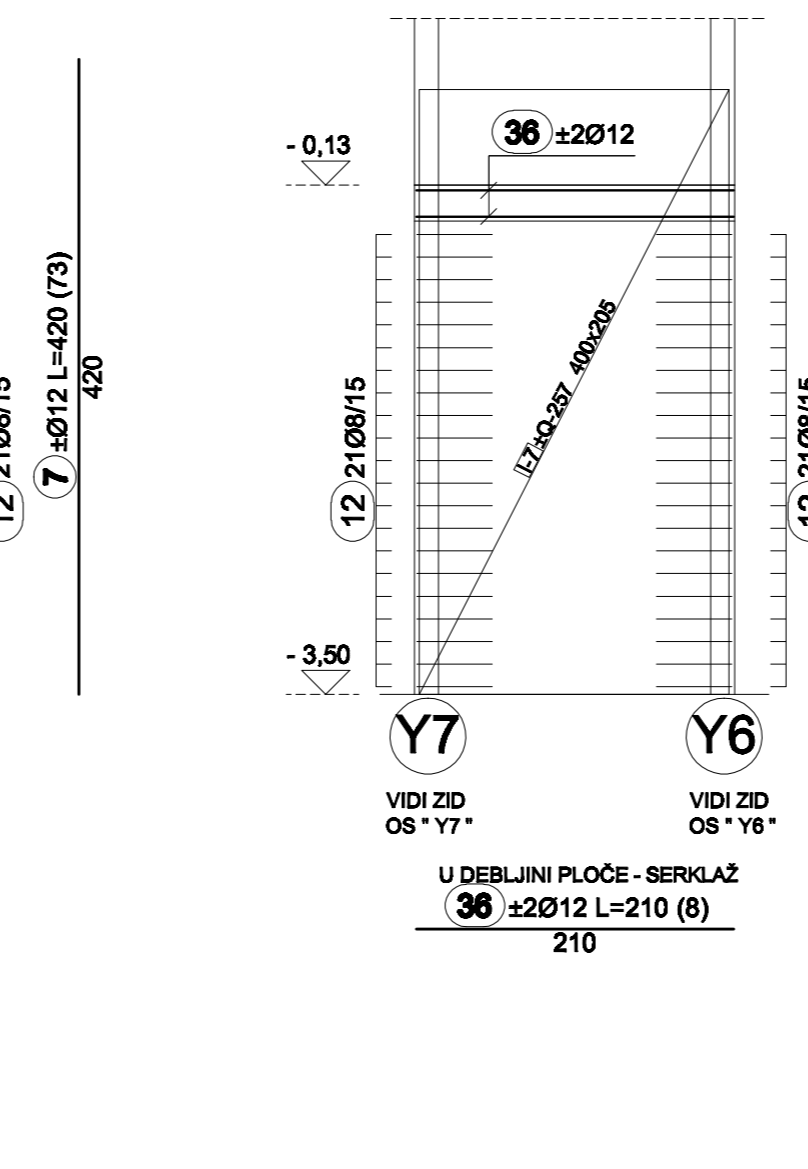

ZID OS - " X7 "

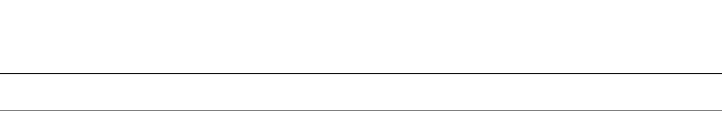
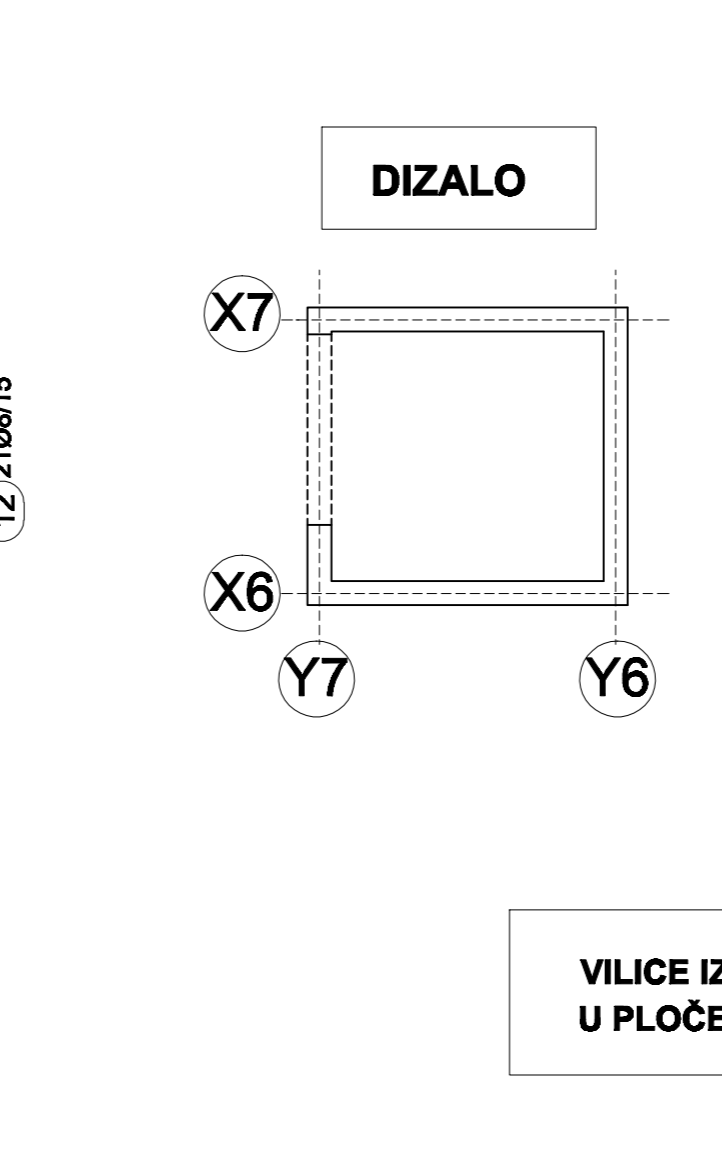

DIZALO

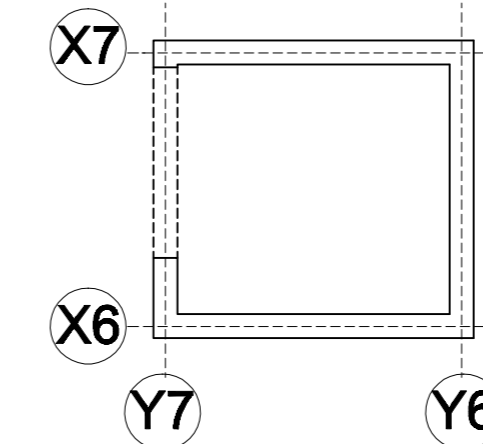

Napomena:
Prije betoniranja zidova OS 2; 3; vidi nastavke u armaturi stepenica List. 14.

VILICE IZ VANJSKIH ZIDOVA (GREDA)
U PLOČE - VIDI ARMATURU PLOČA

PREKLOP MREŽA
a= 30 cm

ZAŠTITNI SLOJ BETONA
c=2,5 cm - 3,0 cm

BETON C25/30
ARMATURA B500B

ZIDOVI DIZALA

Šifra - rekapitulacija	Šifra	Opis	Broj	Jedinična težina [kg]	Ukupna težina [kg]
31	Ø12	17	8	0,78	14,64
32	Ø12	17	8	1,48	28,64
33	Ø12	17	12	1,96	23,52
34	Ø12	17	10	1,96	11,70
35	Ø12	17	8	2,02	16,16
36	Ø12	17	12	2,10	18,90
Ukupno					118,46

Mreža - rekapitulacija	Opis	Broj	Jedinična težina [kg/m²]	Ukupna težina [kg]
Q-267	210 x 600	16	4,02	933,44
Q-335	210 x 600	20	5,26	1307,08
Q-624	210 x 600	5	8,22	530,18
Ukupno				2820,71

Šifra - specifikacija	Opis	Broj	Jedinična težina [kg]	Ukupna težina [kg]
1	Ø12	12	3,36	63,00
2	Ø12	14	2,00	20,00
3	Ø12	8	1,80	14,40
4	Ø12	8	1,15	10,80
5	Ø12	10	3,36	103,76
6	Ø12	12	6,00	108,00
7	Ø12	12	4,20	100,80
8	Ø12	12	4,18	101,34
9	Ø12	12	2,00	18,00
10	Ø12	8	1,54	28,16
12	Ø12	8	1,12	207,20
13	Ø12	8	0,86	14,62
14	Ø12	16	2,80	10,40
15	Ø12	14	3,50	14,00
16	Ø12	12	3,10	12,40
17	Ø12	12	4,80	18,00
18	Ø12	8	1,80	79,20
19	Ø12	10	3,10	48,50
20	Ø12	14	3,85	29,20
21	Ø12	14	4,70	18,80
22	Ø12	10	4,70	94,00
23	Ø12	10	1,15	144,90

PODRUM - ZIDOVI SMJER " X "

Br. revizija:	REVIZIJA	Datum revizije:
GLAVNI PROJEKTANT: Sanela Baganović, dipl.ing.arh.	PROJEKTANT KONSTRUKCIJE: Branko Galčić, dipl.ing.graf.	GRAĐEVINA: ZGRADA CENTRA HRVATSKOG CRVENOG KRŽA U KOPRNIKESOCIJALNIH USLUGA U ZAJEDNICI
SURADNICI: Vlaho Mijanović, mag.ing.aedif.	MJERILO: 1:50	DATA: 02/2021
Toma Čurković, mag.ing.aedif.	BR.PR.TD: 135/2020	BR.NACRTA: 3
Lara Antulov-Fantulin, mag.ing.aedif.		

ZID OS - " A "

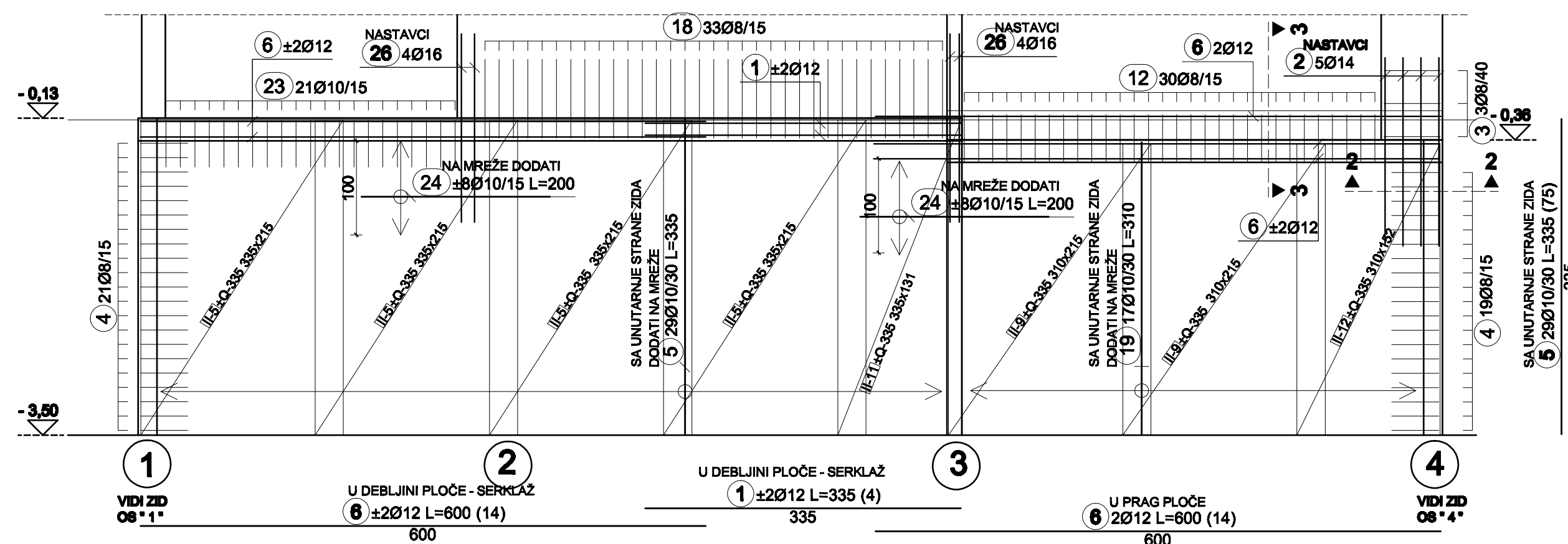

ZID OS - " A1 "

(" Y2 ")

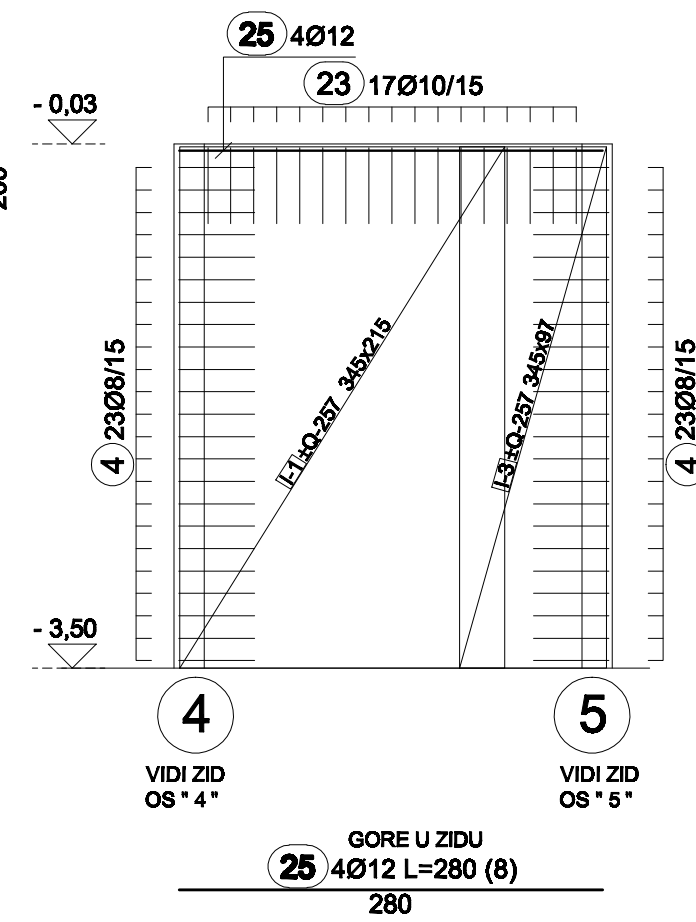

ZID OS - " B1 "

(" Y4 ")

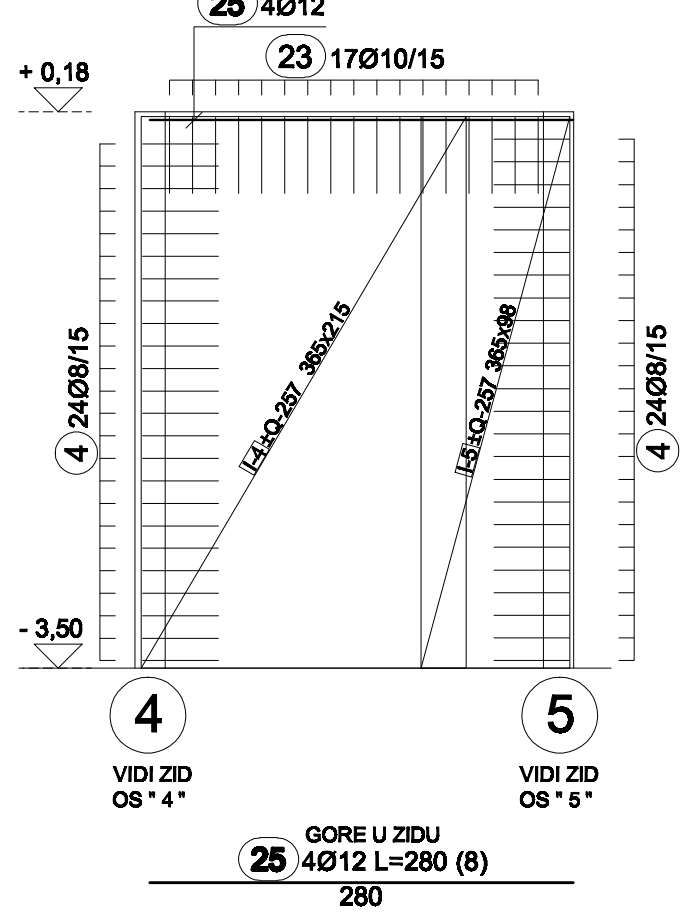

ZID OS - " B "

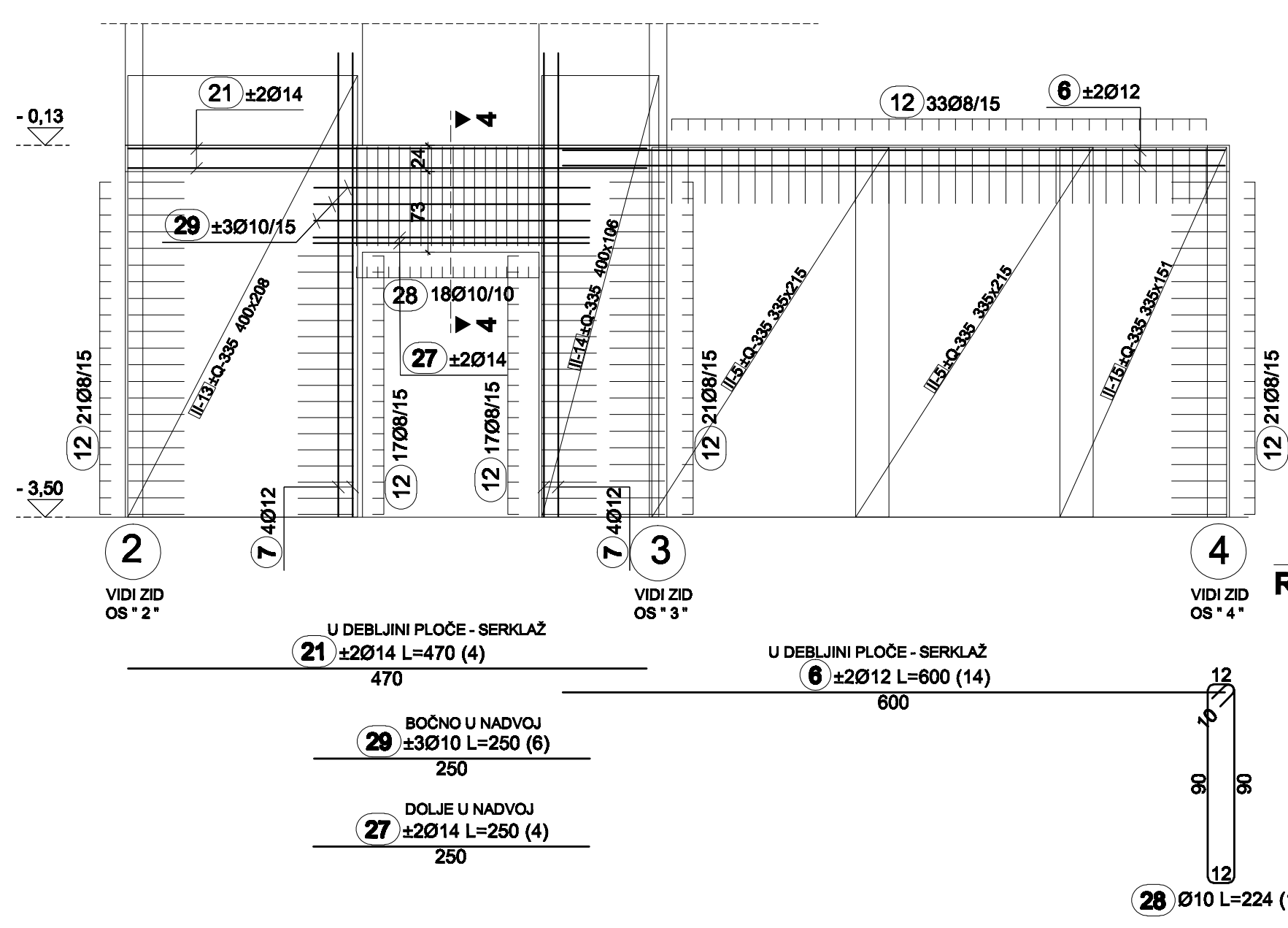

ZID OS - " C "

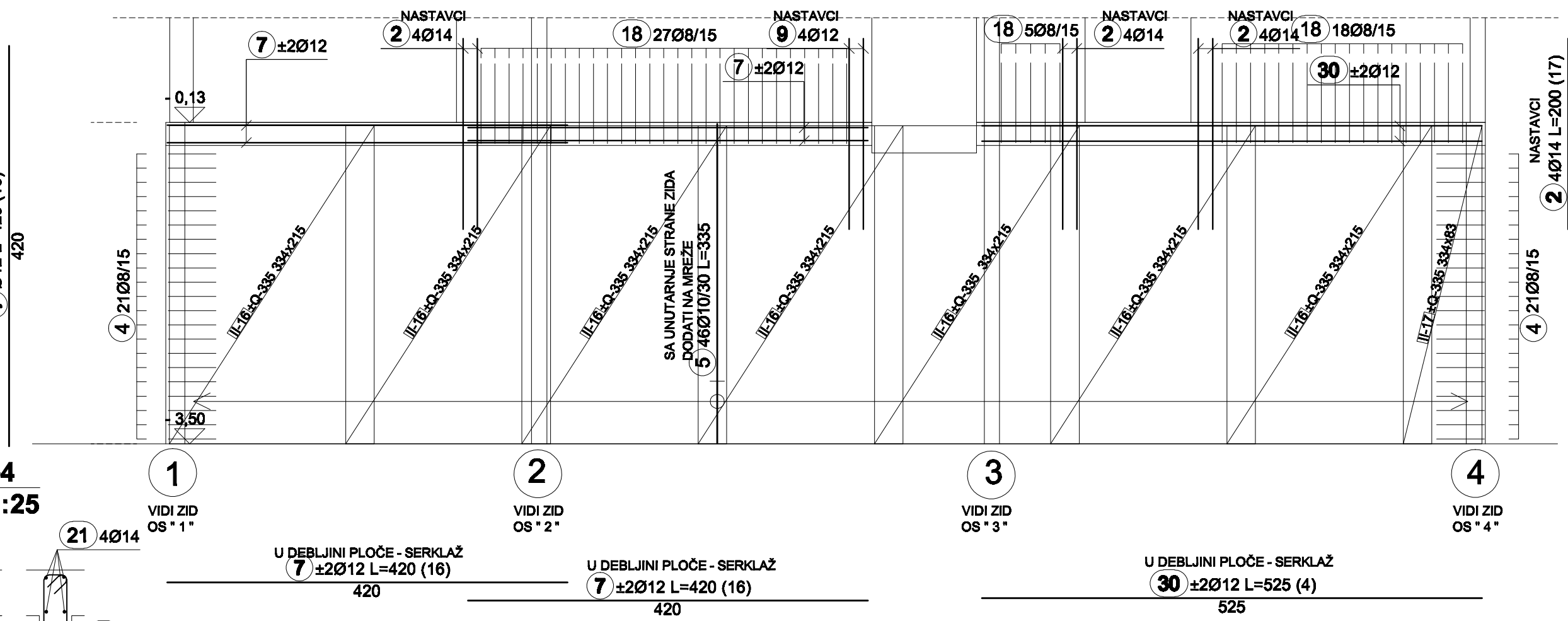

VILICE IZ VANJSKIH ZIDOVA (GREDA) U PLOČE - VIDI ARMATURU PLOČA

Oznaka mreže	B [cm]	L [cm]	n	Jedinična težina [kg/m ²]	Ukupna težina [kg]
Q-257	215	600	6	4.02	311.15
Q-335	215	600	39	5.28	2048.31
Ukupno					2359.46

ozn	oblik i mjera [cm]	Ø	lg [m]	n [kom]	lg ³ [m ³]
nomena (1 kom)					
1	335	12	3.35	4	13.40
2	200	14	2.00	17	34.00
3	80	8	1.80	3	5.40
4	80	8	1.15	176	202.40
5	335	10	3.35	76	261.25
6	600	12	6.00	14	84.00
7	420	12	4.20	16	67.20
9	200	12	2.00	4	8.00
12	80	8	1.12	160	179.20
18	84	8	1.80	83	149.40
19	310	10	3.10	17	62.70
21	470	14	4.70	4	18.80
23	80	10	1.15	55	63.25
24	200	10	2.00	32	64.00
25	280	12	2.80	8	22.40
26	200	16	2.00	8	16.00
27	200	14	2.50	4	10.00
28	80	10	2.24	18	40.32
29	80	10	2.50	8	15.00
30	225	12	5.25	4	21.00

Ø [mm]	lg [m]	Jedinična težina [kg/m ³]	Težina [kg]
S 500			
8		536.40	0.40
10		486.52	0.82
12		216.00	0.89
14		62.80	1.21
16		18.00	1.98
Ukupno			805.14

PODRUM - ZIDOV I SMJER " Y "

Br. revizije:	REVIZIJA	Datum revizije:
---------------	----------	-----------------

RADIONICA STATIKE d.o.o. Anđelka Kačić Mihalčić 22, 10 000 Zagreb tel: +385 (1) 30 20 444 fax: +385 (1) 30 20 445 e-mail: radionica@statike.hr		INVESTITOR: HRVATSKI CRVENI KRIŽ Ulica Crvenog križa 14-16, 10000 Zagreb OIB: 72527253659	
GLAVNI PROJEKTANT: Seneša Begonović, dipl.ing.arh.	GRAĐEVINA: ZGRADA CENTRA HRVATSKOG CRVENOG KRIŽA U KORISNIKESOCIJALNIH USLUGA U ZAJEDNICI	LOKACIJA: Zagreb, Dubravkin trg 11 k.č.br: 277, k.o. Trnje	FAZA PROJEKTA: IZVEDBENI GRAĐEVINSKI PROJEKT
SURADNICI: Vlaho Miljanović, mag.ing.aedif.	SADRŽAJ: PODRUM - ZIDOV I - SMJER " Y "	MJERILO: 1:50	DATUM: 02/2021
Tomo Čurković, mag.ing.aedif. Lara Antulov-Fantulin, mag.ing.aedif.	BR.PR.-TD 135/2020	BR.NACRTA: 4	

Napomena:
Prije betoniranja zidova OS C; vidi nastavke u armaturi stepenica List. 14.

PREKLOP MREŽA
a = 30 cm

ZAŠTITNI SLOJ BETONA
c=2,5 cm - 3,0 cm

BETON C25/30
ARMATURA B500B

DONJA ZONA

GORNJA ZONA

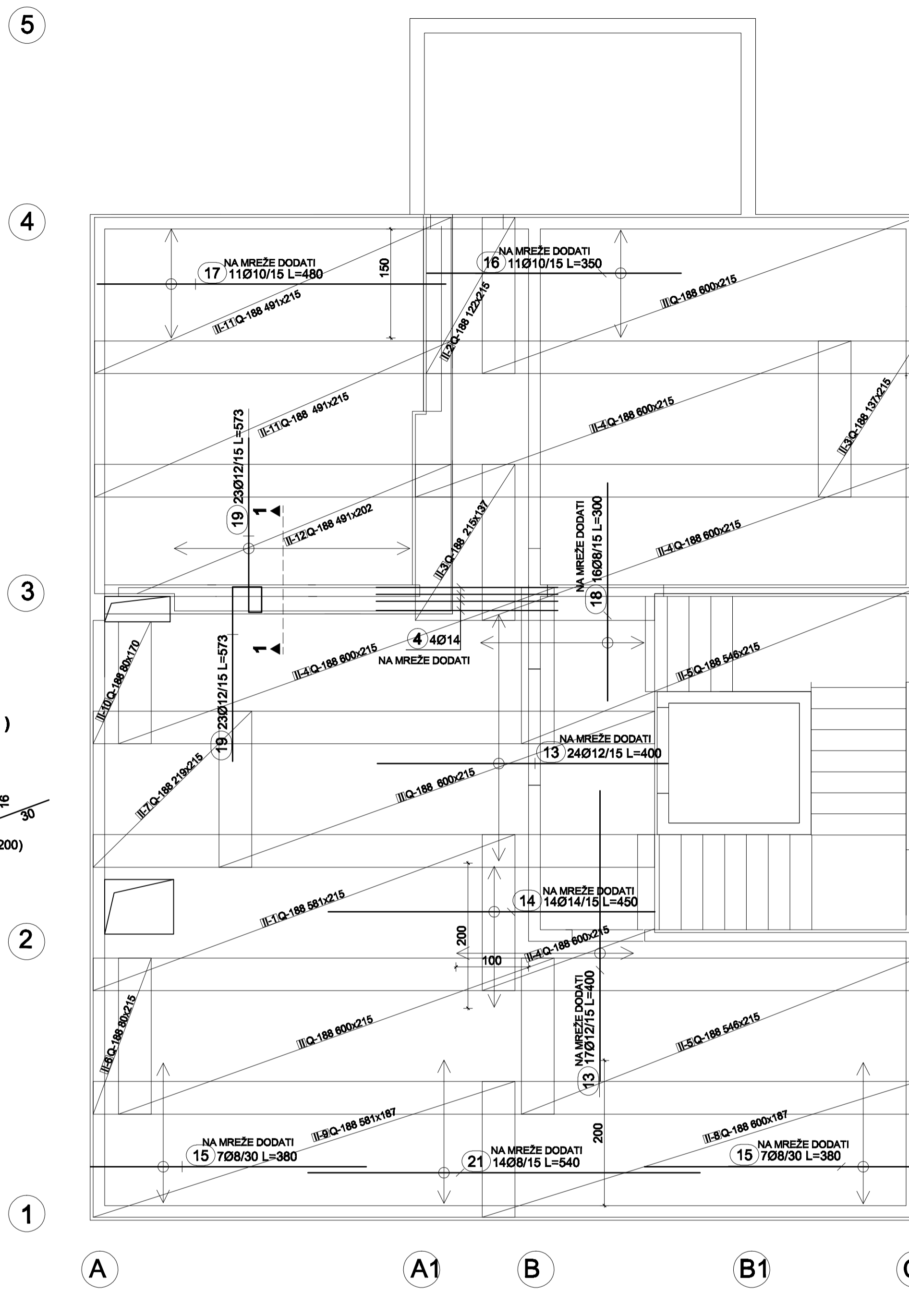
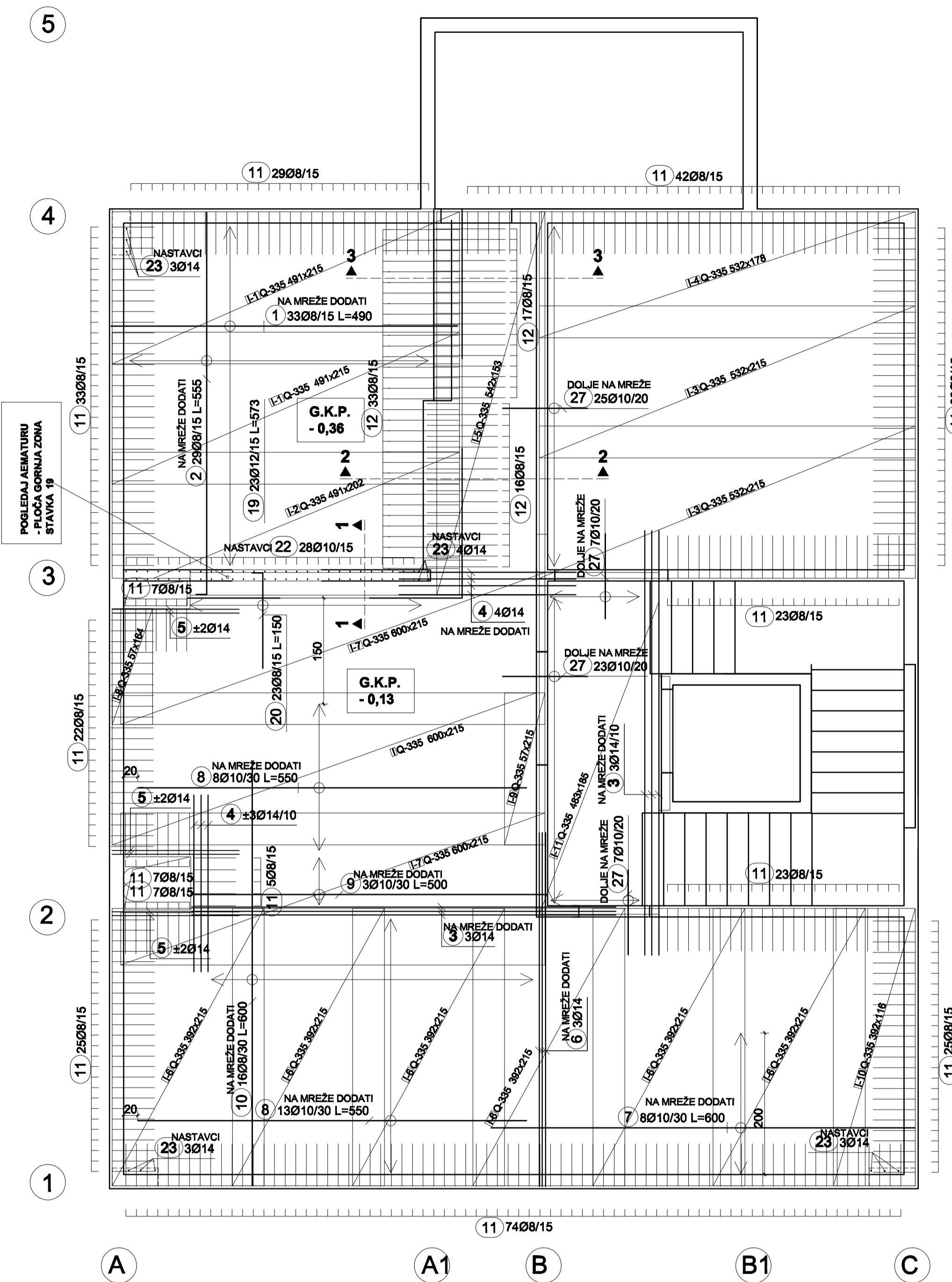

JAHAČI (DISTANCERI)

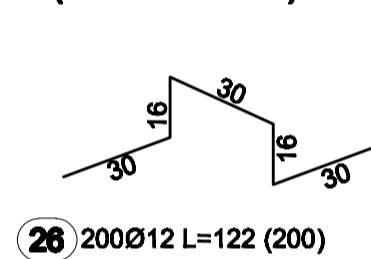

Šipke - specifikacija

ozn	oblik i mjere [mm]	Ø	lg [m]	n [kom]	lgm [m]
1	400	8	4,90	33	161,70
2	640	8	5,55	29	160,95
3	600	14	6,00	6	36,00
4	200	14	2,50	14	35,00
5	200	14	2,20	12	26,40
6	600	14	5,00	3	15,00
7	600	10	6,00	40	240,00
8	600	10	5,80	21	115,80
9	600	10	5,00	3	15,00
10	600	8	6,00	16	96,00
11	60	8	1,36	356	482,80
12	100	8	2,16	66	142,88
13	400	12	4,00	41	164,00
14	400	14	4,50	14	63,00
15	300	8	3,80	14	53,20
16	300	10	3,50	11	38,50
17	400	10	4,80	11	52,80
18	300	8	3,00	16	48,00
19	240	12	5,75	23	131,75
20	130	8	1,90	23	34,80
21	640	8	5,40	14	75,60
22	114	10	2,40	28	67,20
23	114	14	1,85	13	21,45
24	40	8	1,70	36	61,20
25	40	8	2,00	16	32,00
26	30	12	1,22	200	244,00
27	130	10	1,20	62	74,40

Šipke - nakupljenja

Ø [mm]	lgm [m]	Jedninska težina [kg/m]	Težina [kg]
		8 500	
8	1353,61	0,40	534,68
10	603,40	0,82	372,30
12	538,79	0,89	479,33
14	198,85	1,21	238,19
Ukupno			1624,50

Mreže - nakupljenja

Oznaka mreže	B [cm]	L [cm]	n	Jedninska težina [kg/m²]	Ukupna težina [kg]
Q-335	215	600	18	5,28	1221,37
Q-188	215	600	17	2,96	649,13
Ukupno					1870,50

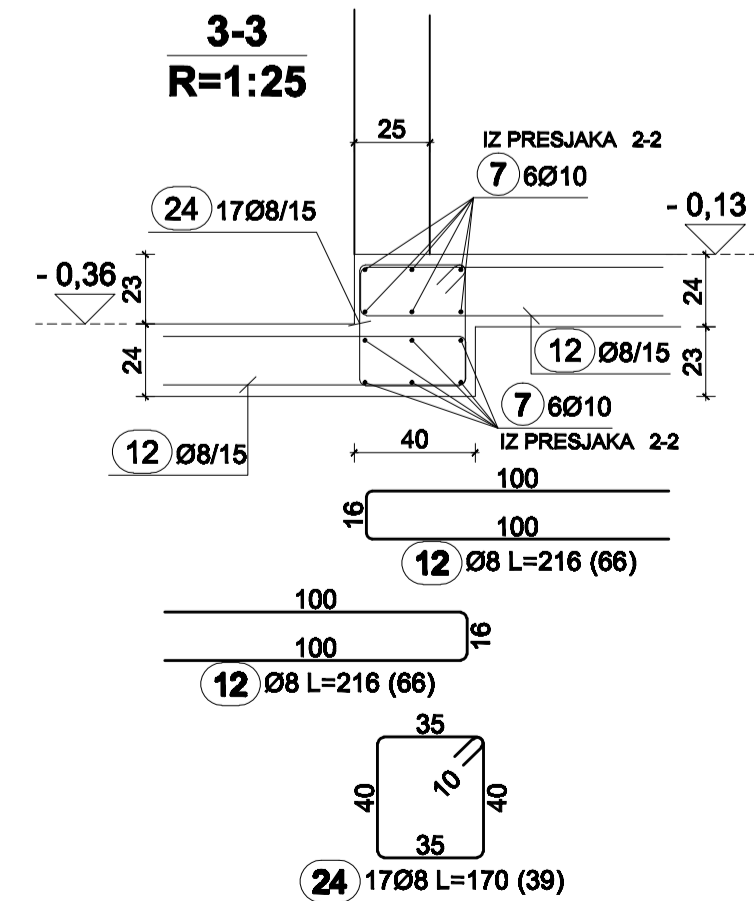
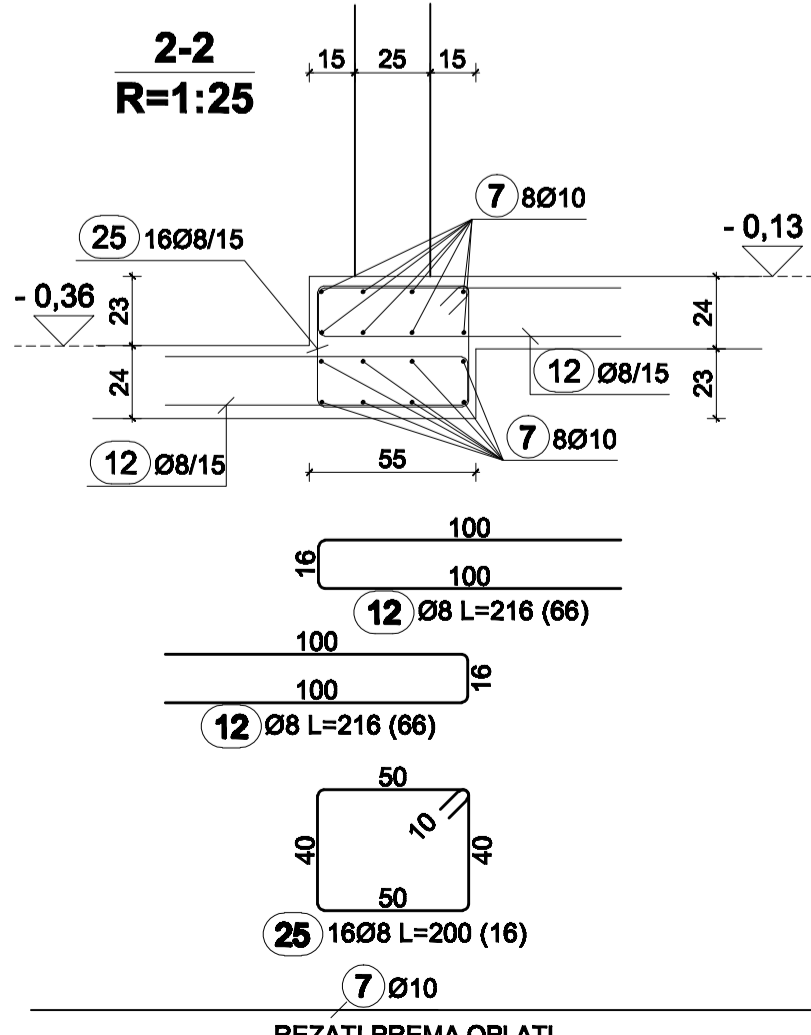
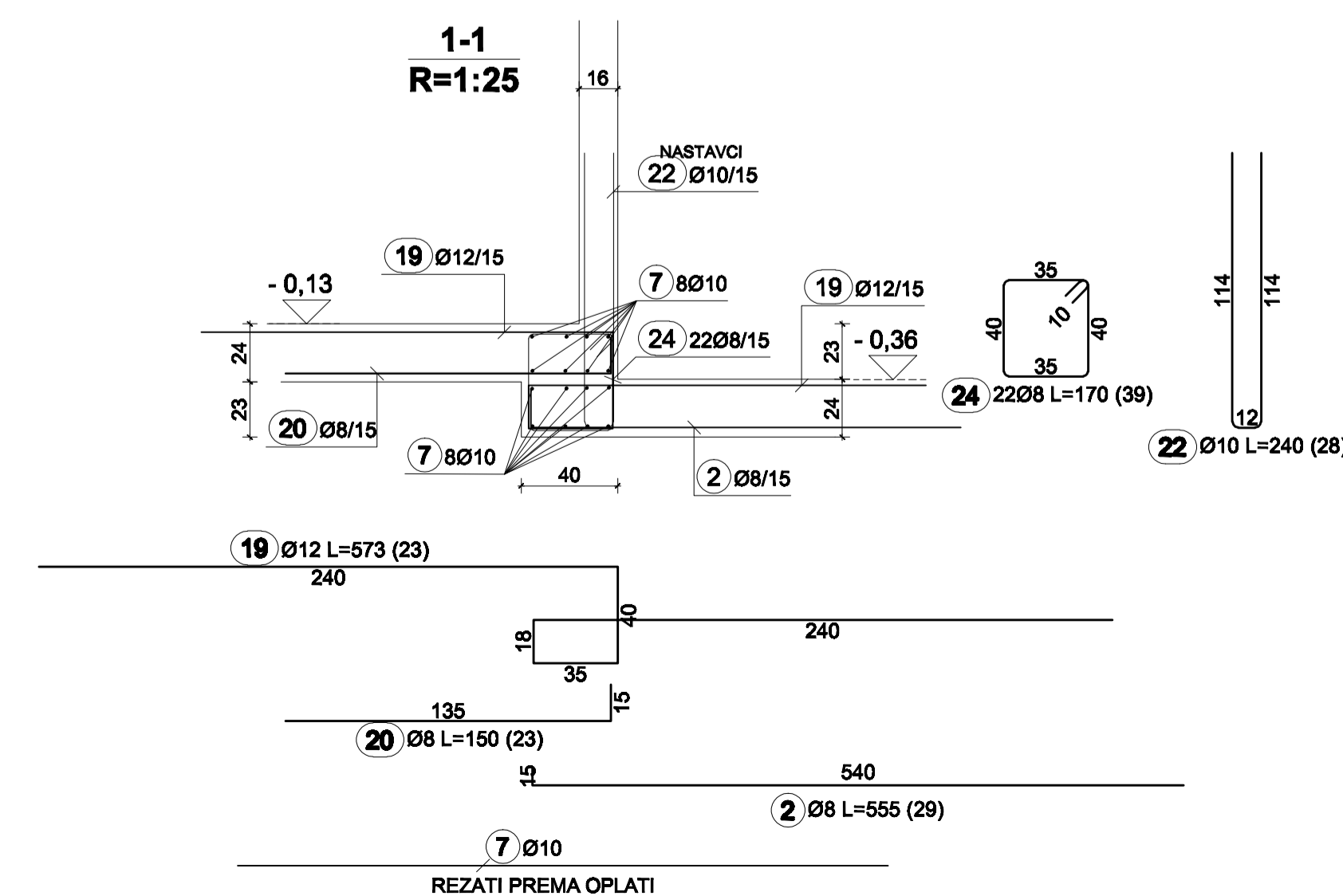

- ARMATURU HORIZONTALNIH SERKLAŽA - VIDI NACRT - PODRUM - ARMATURA ZIDOVA, (ako nije drugačije naznačeno).

PODRUM ARMATURA PLOČE

PREKLOP MREŽA a = 45 cm

ZAŠITNI SLOJ BETONA c=2,5 cm

BETON C25/30 ARMATURA B500B

Br. revizije:	REVIZIJA	Datum revizije:
GLAVNI PROJEKTANT:	Senela Beganović, dipl.ing.arh.	INVESTITOR:
PROJEKTANT KONSTRUKCIJE:	Branko Galić, dipl.ing.grad.	HRVATSKI CRVENI KRIŽ Ulica Cvetnog križa 14-16, 10000 Zagreb OIB: 7252723859
SURADNICI:	Visho Miljanović, mag.ing.aedif. Toma Čurković, mag.ing.aedif. Lara Antulov-Fantulin, mag.ing.aedif.	ZGRADA CENTRA HRVATSKOG CRVENOG KRIŽA U KORISNIKESOCIALNIH USLUGA U ZAJEDNICI LOKACIJA: Zagreb, Dubravkin trg 11 k.o.br. 271, k.o. Trnje FAZA PROJEKTA: IZVEDBENI GRAĐEVINSKI PROJEKT SADRŽAJ: PODRUM - PLOČE MJERILO: 1:50 BR.PR.:TD 135/2020 BR.NACRTA: 5
DATUM: 02/2021		

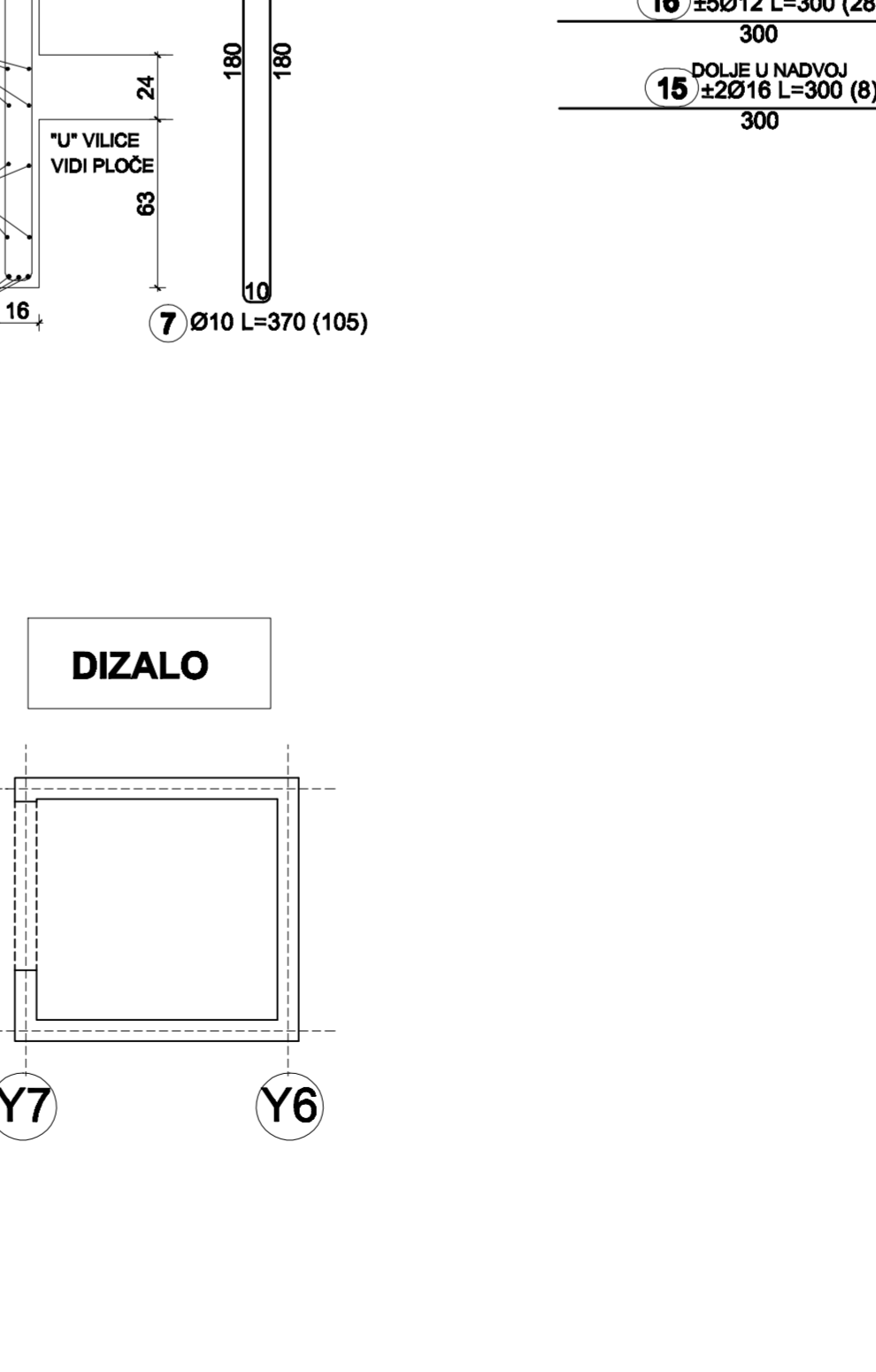
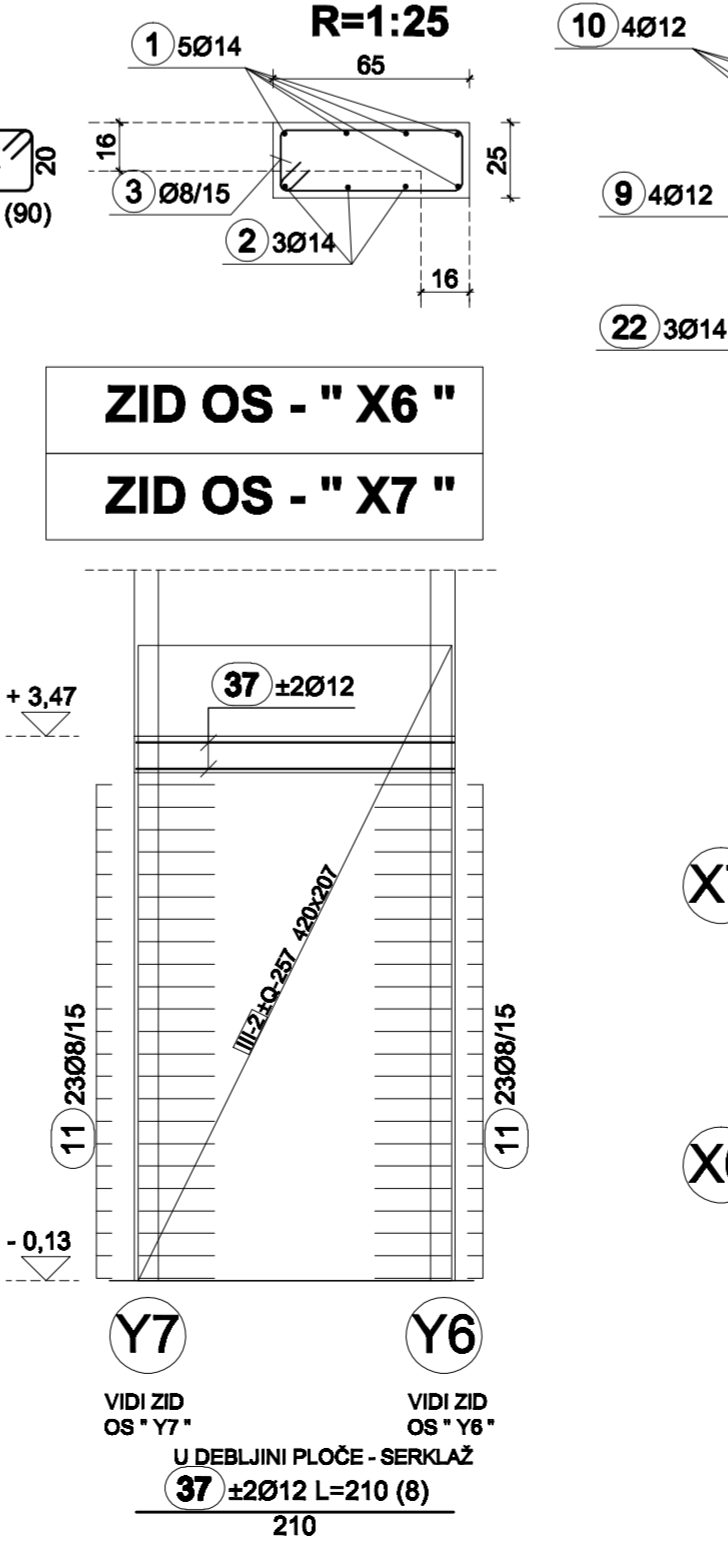
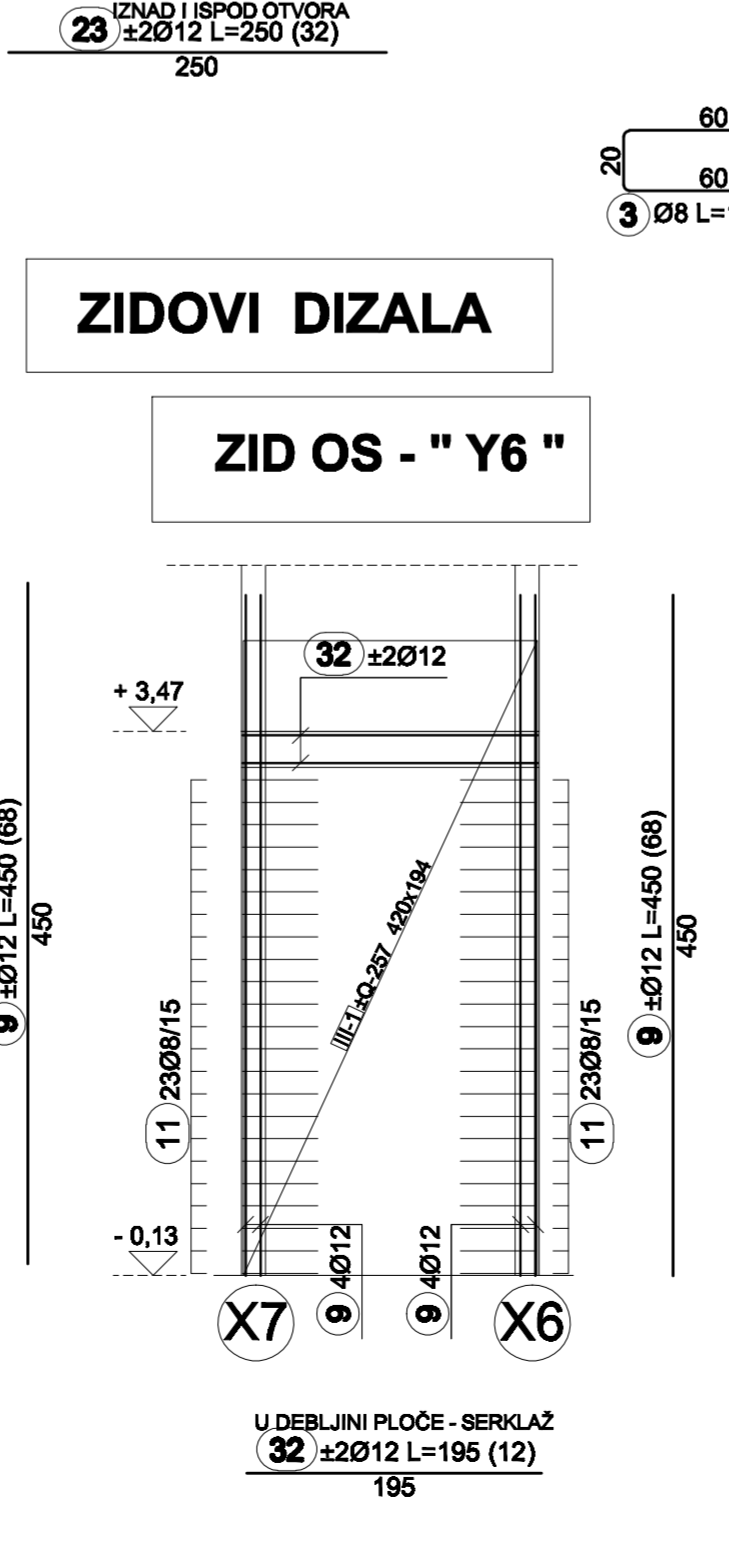
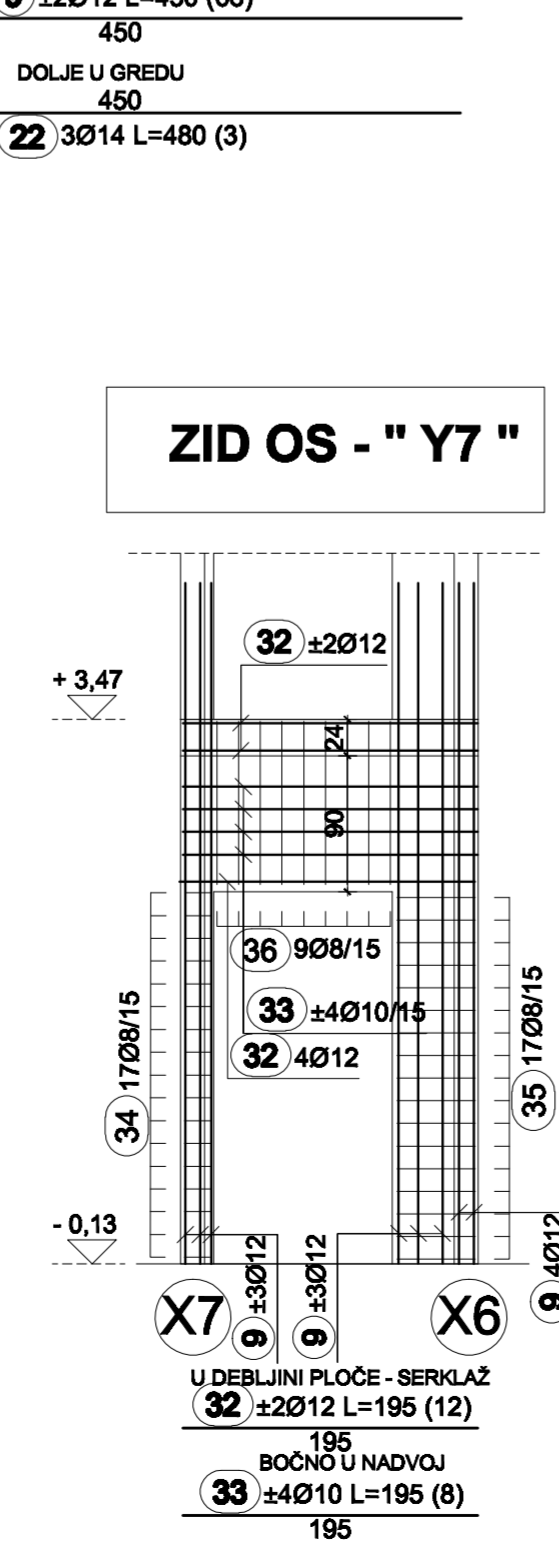
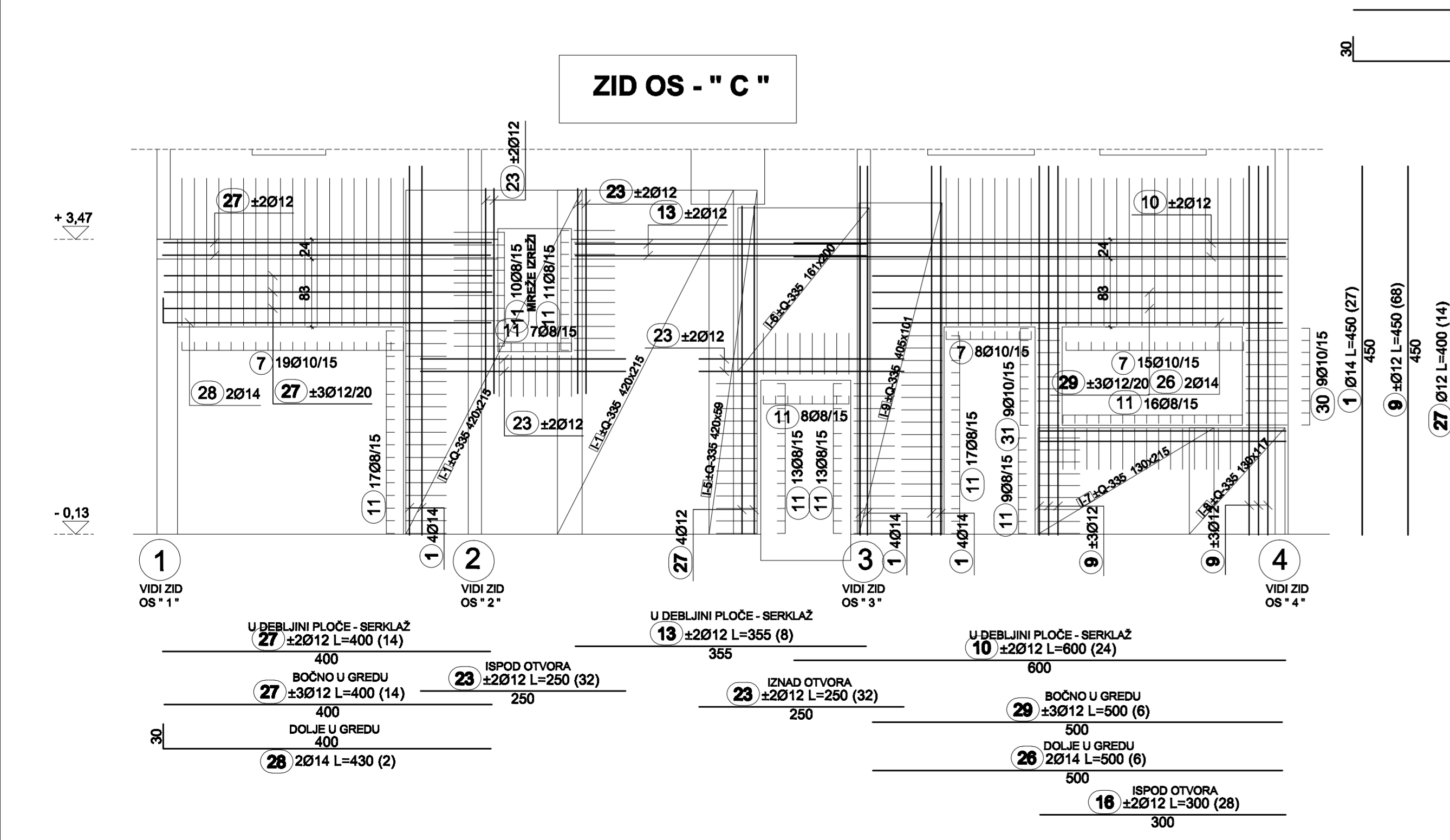
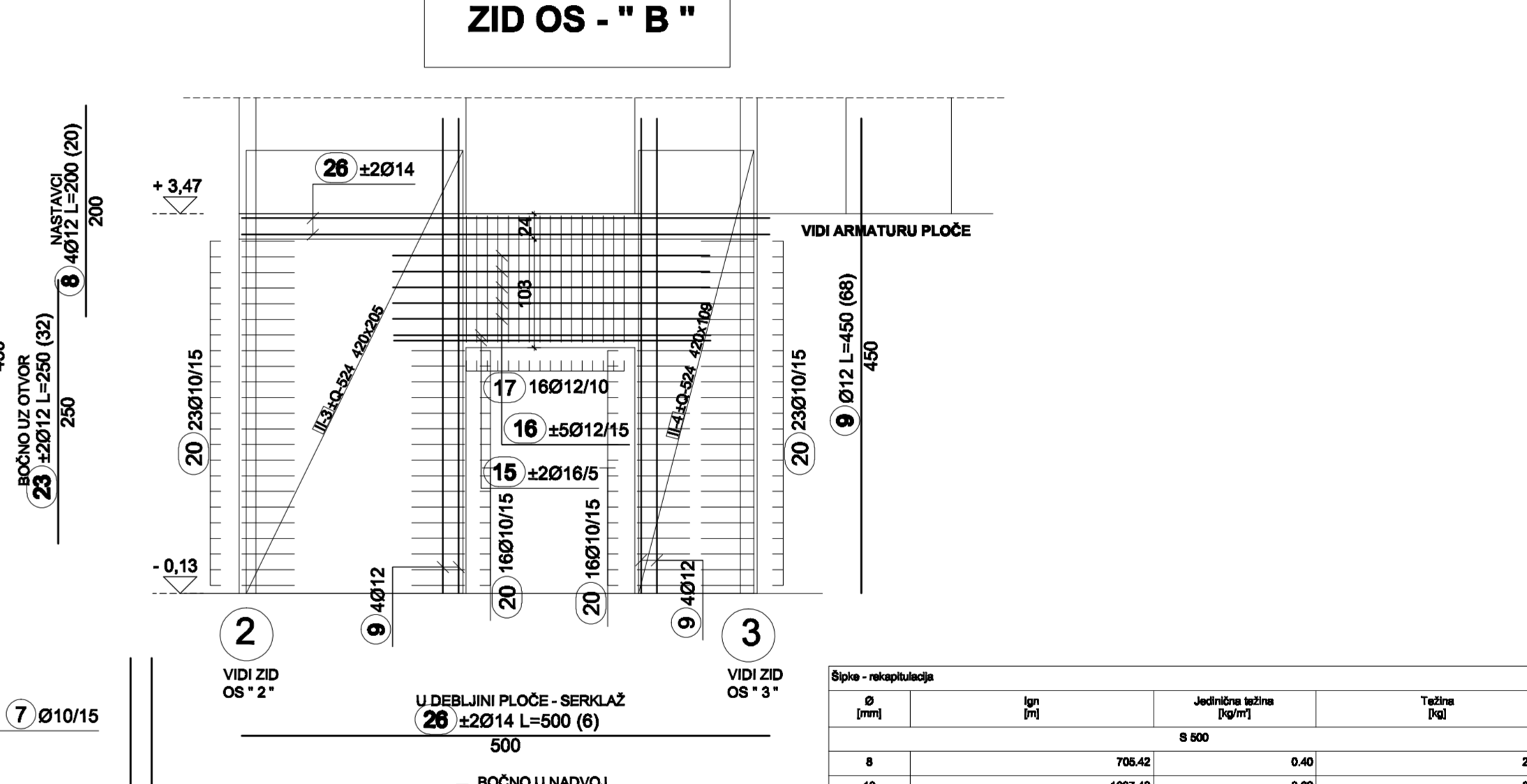
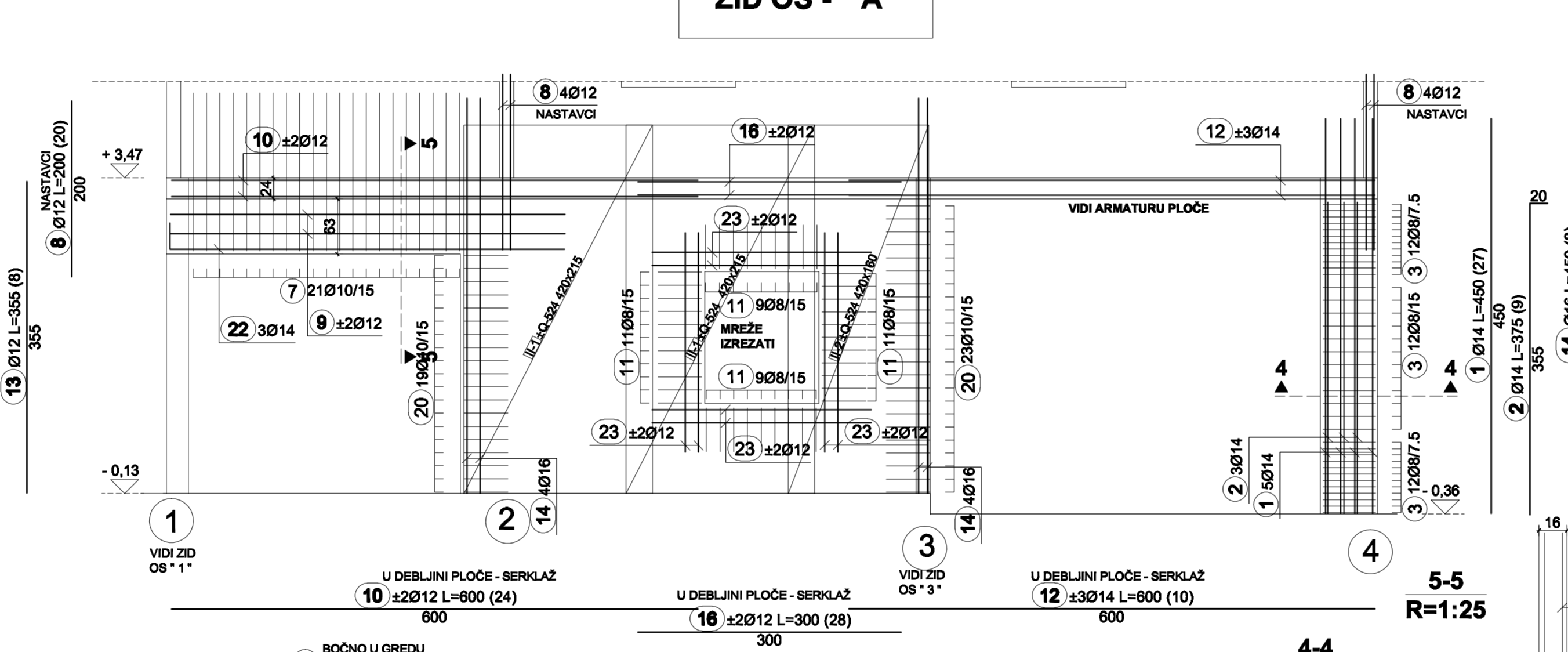
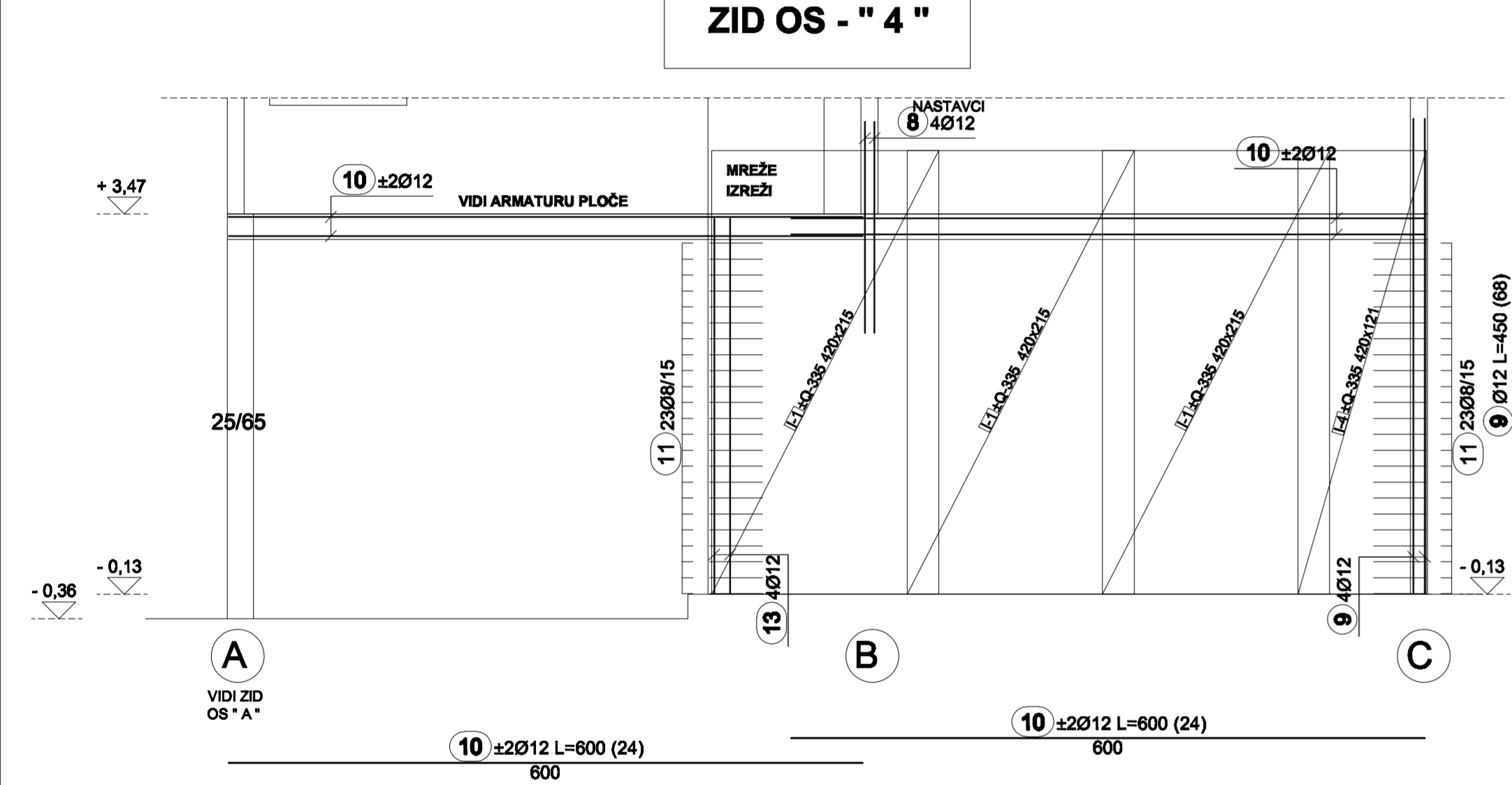
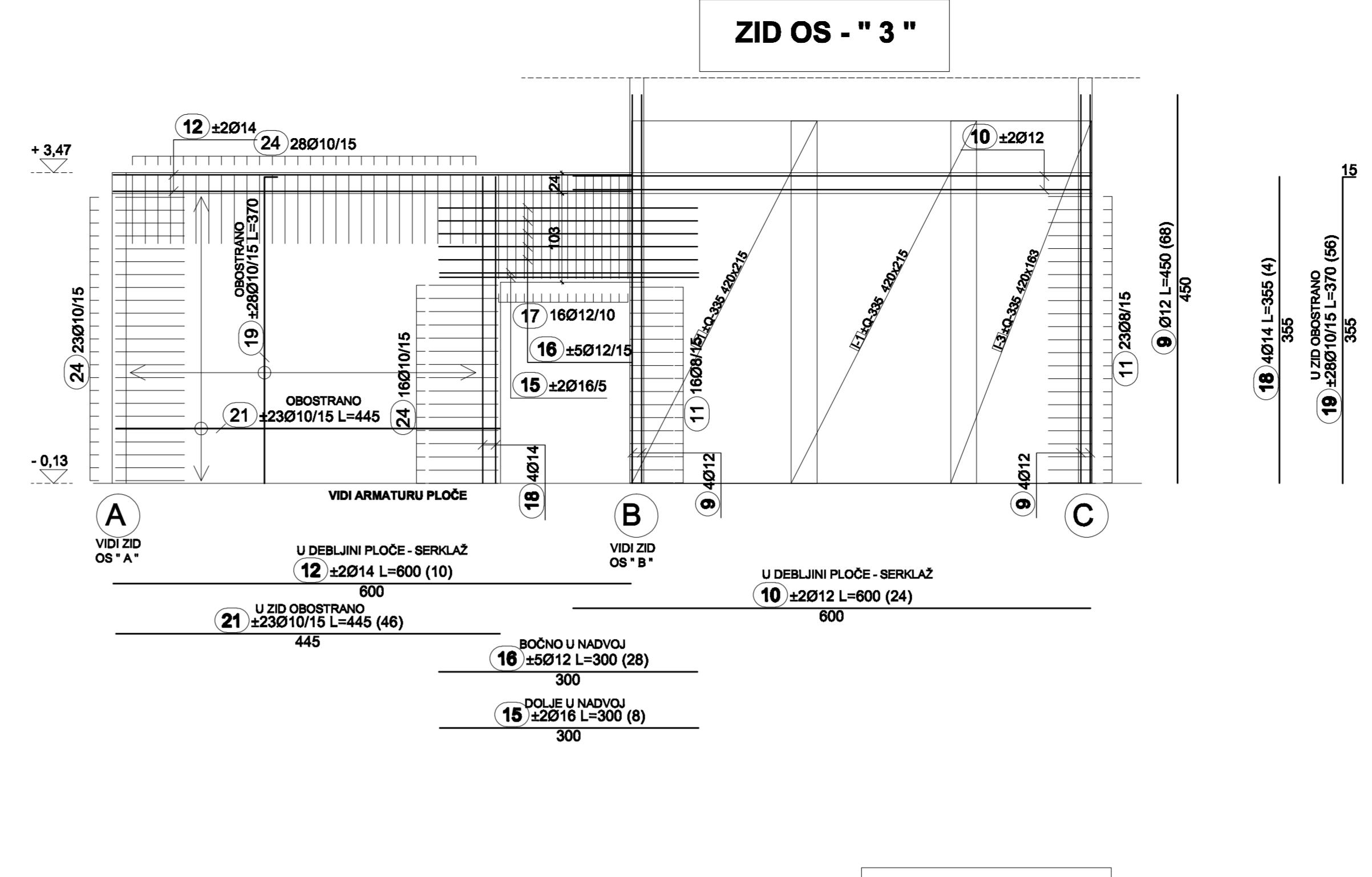
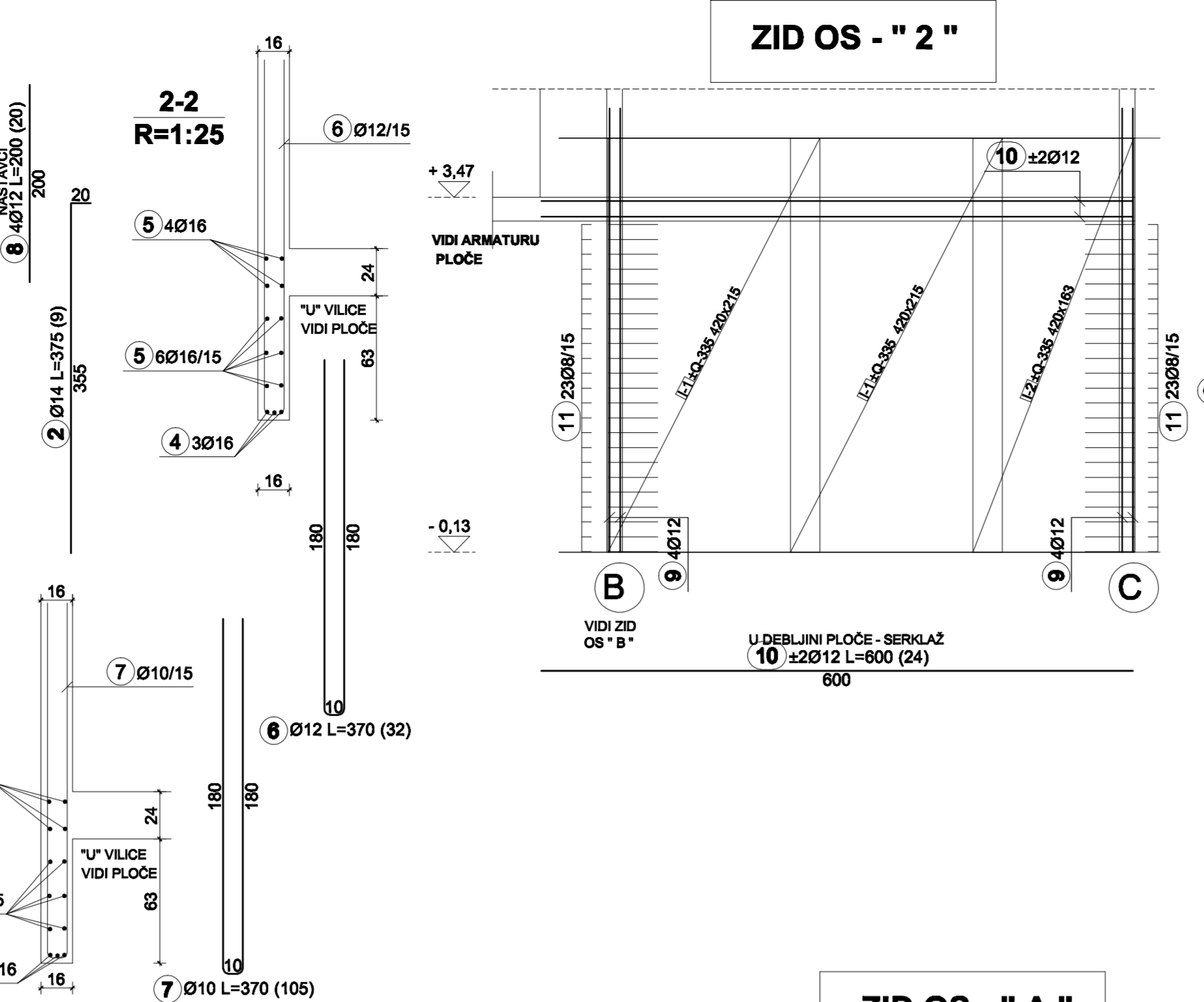
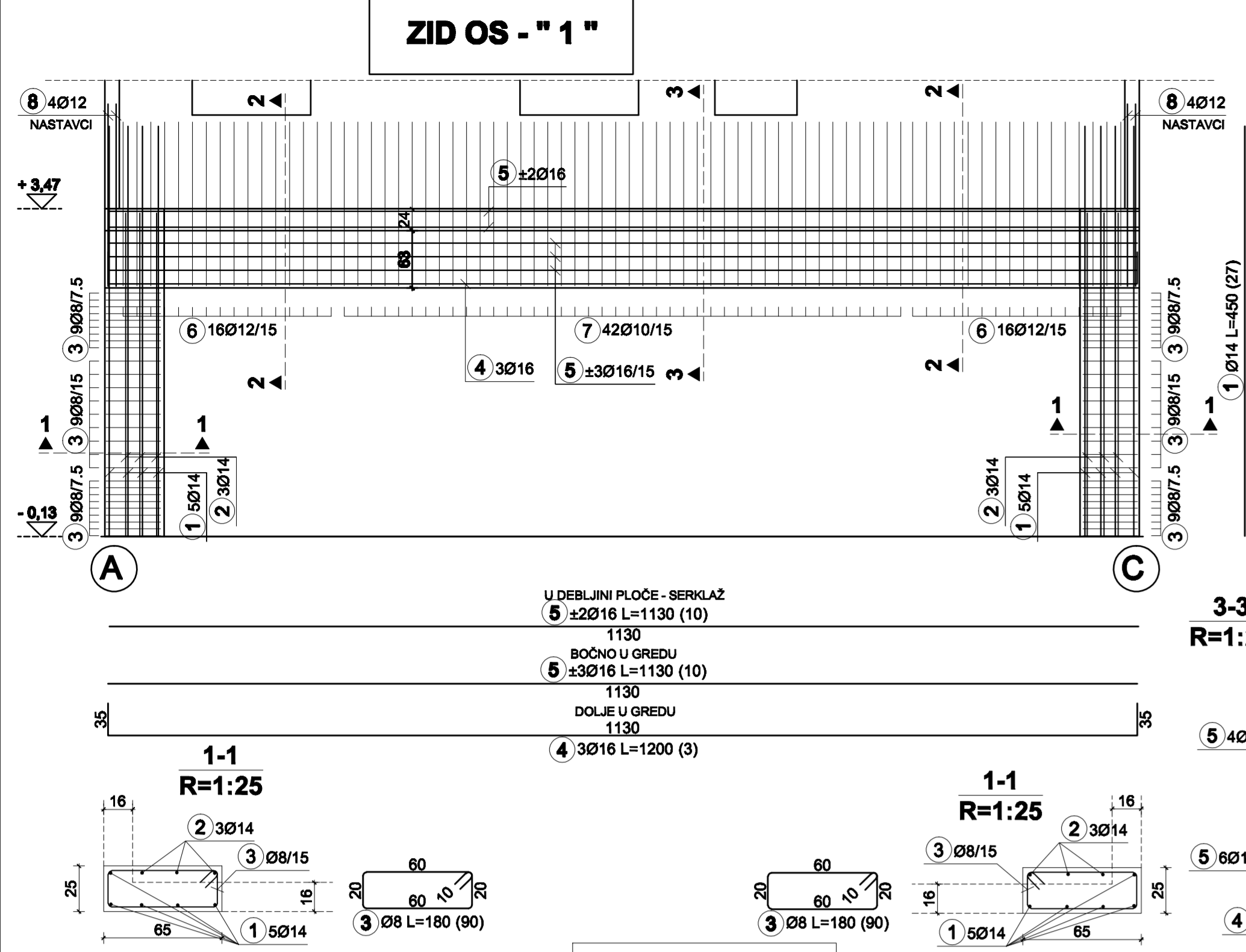

Šifra - rekapitulacija	Q (m³)	Ukupna površina (m²)	Tehn. Ploča
8	706.42	0.40	278.94
10	1067.42	0.62	676.94
12	1017.88	0.98	600.80
14	382.40	1.21	341.76
16	209.00	1.08	330.22
Ukupno	2684.12		2628.66

Mreža - rekapitulacija	Drnačka mreža (m²)	L (m)	n	Ukupna mreža (kg)
Q-230	215	600	20	5.30
Q-301	215	800	10	8.32
Q-207	215	600	6	4.02
Ukupno				307.66

Napomena:
 Prije betoniranja zidova OS 2, 3 i C, videti nastavke u armaturi stepenica List. 14.

VILICE IZ VANJSKIH ZIDOVA (GREDA)
 U PLOČE - VIDI ARMATURU PLOČA

PREKLOP MREŽA
 a= 30 cm

ZAŠTITNI SLOJ BETONA
 c=2,0 cm - 2,0 cm

BETON C25/30
 ARMATURA B500B

Šifra - rekapitulacija	Q (m³)	Ukupna površina (m²)	Tehn. Ploča
1	400	14	4.50
2	300	6	3.75
3	60	6	1.80
4	1130	16	12.00
5	1130	16	11.30
6	180	12	3.70
7	180	10	3.70
8	300	12	2.00
9	400	12	4.00
10	600	12	6.00
11	60	8	1.12
12	600	14	6.00
13	300	12	3.20
14	300	12	4.00
15	300	12	3.00
16	300	12	3.00
17	180	12	2.84
18	300	14	3.66
19	300	10	3.70
20	60	10	1.12
21	445	10	4.46
22	480	14	4.80
23	250	12	2.50
24	60	10	1.72
26	600	14	5.00
27	400	12	4.00
28	600	14	4.30
29	600	12	5.00
30	60	10	1.44
31	27	10	0.98
32	196	12	1.80
33	196	10	1.80
34	17	8	0.78
35	17	8	0.78
36	62	8	1.48
37	180	8	2.40
38	210	12	2.10

PRIZEMLJE - ZIDOV

Br. revizije	REVIZIJA	Datum revizije

RADIONICA STATIKE	INVESTITOR: HRVATSKI CRKVENI KIZUZ Ulica Červinskog br.14-16, 10000 Zagreb OIB: 72527232658
GLAVNI PROJEKTANT: PROJEKTANT KONSTRUKCIJE:	BRANKO GALIĆ, dipl.ing.grad. <i>B. Galic</i>
SURADNICI:	Viaho Mijanović, mag.ing.aedf. Toma Čurković, mag.ing.aedf. Lars Antunov-Fantulin, mag.ing.aedf.
GRADEVINA:	ZGRADA CENTRA HRVATSKOG CRKVENOG KIZUZA U KORNIKOSKOGLJANCIH USLUGA U ZAJEDNICI
LOKACIJA:	Zagreb, Špiljski trg 11 KIZUZ, 27.10.1991
FAZA PROJEKTA:	IZVEDBENI GRAĐEVINSKI PROJEKT
SADRŽAJ:	PRIZEMLJE - ZIDOV
MJERLO: 1:50	DATUM: 02/2021
BR.PR.-TD	135/2020
BR.NACRTA:	6

DONJA ZONA

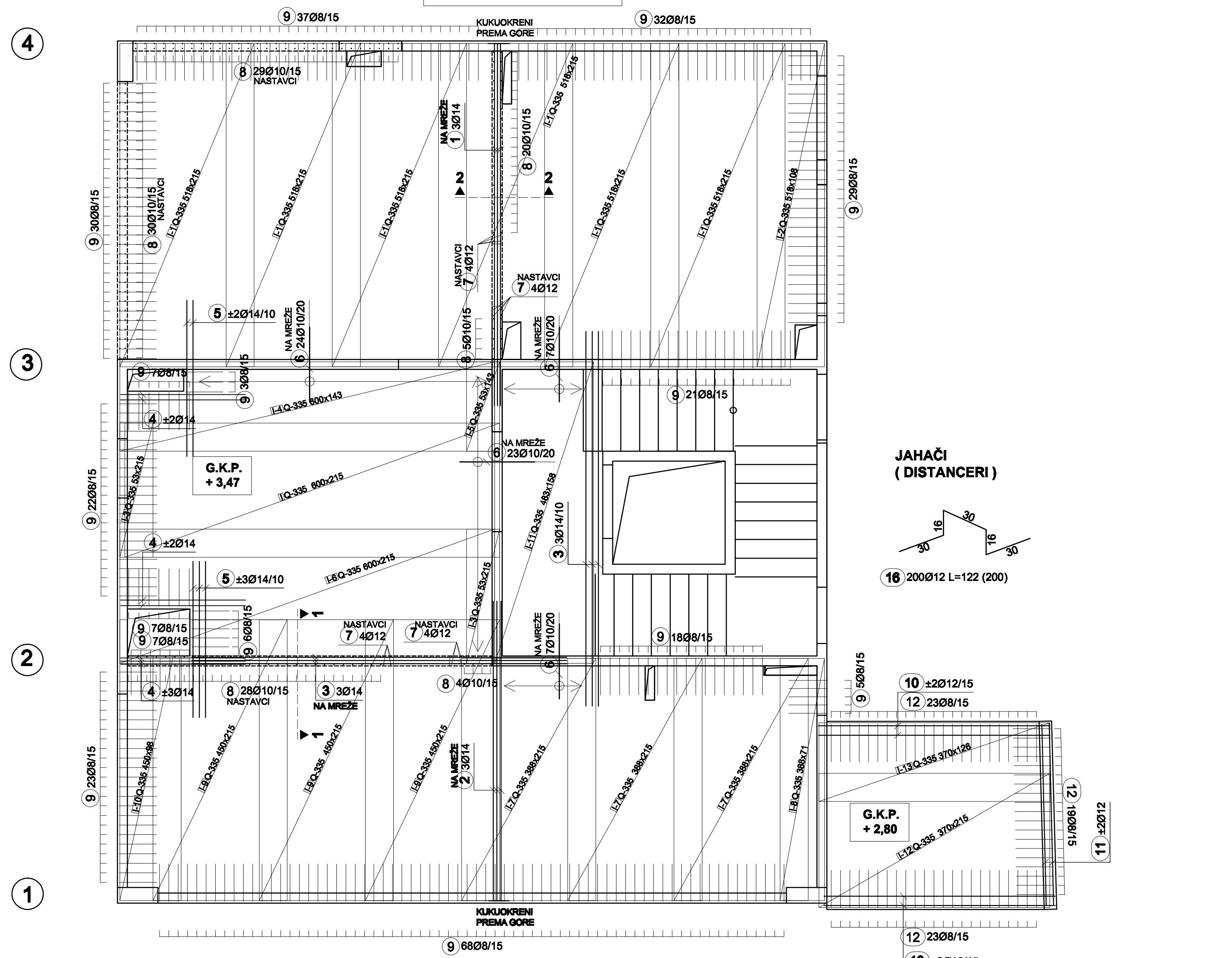

JAHČI (DISTANCERI)

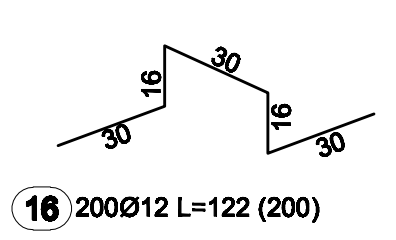

GORNJA ZONA

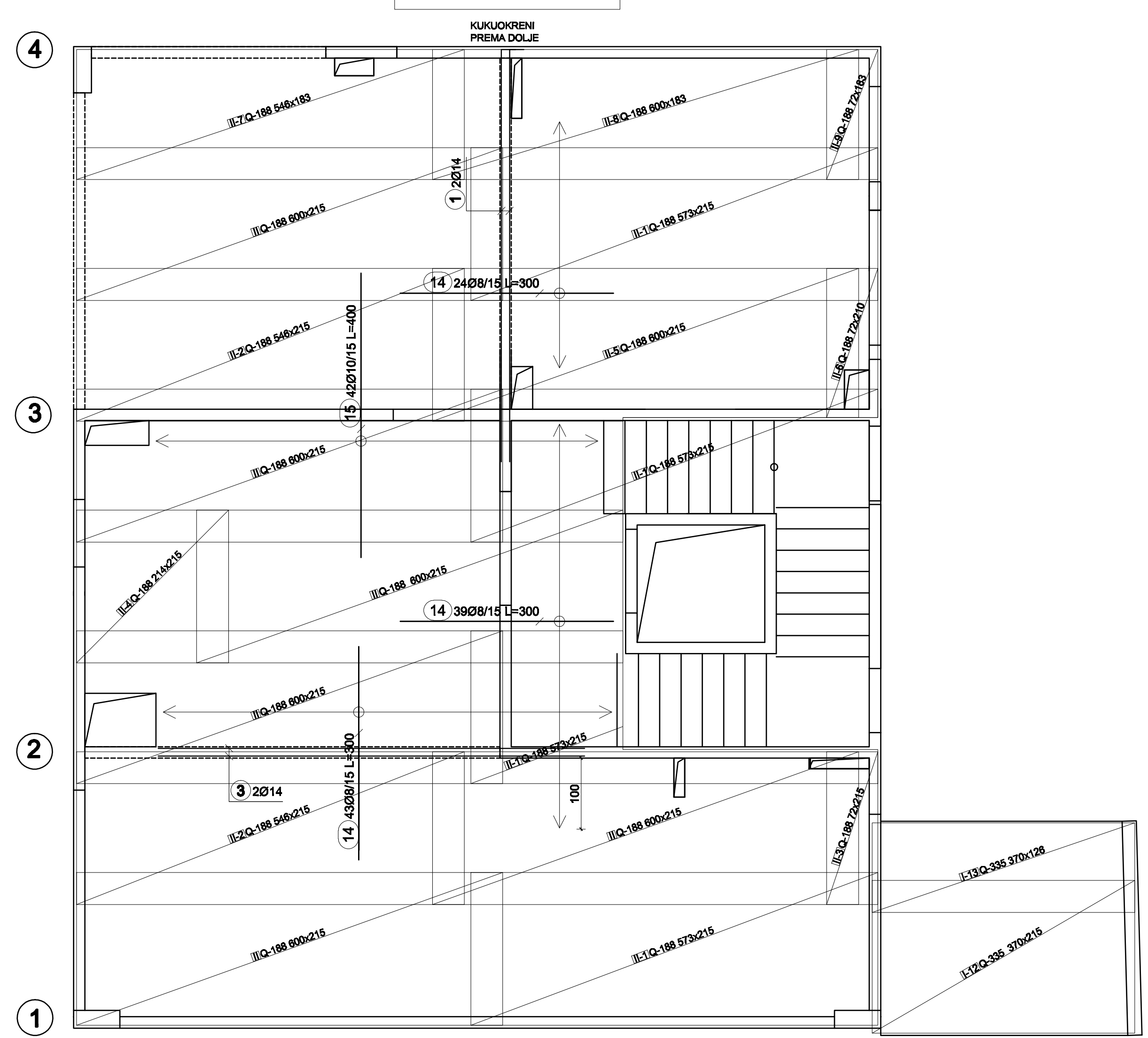

- ARMATURU HORIZONTALNIH SERKLAŽA - VIDI NACRT - PRIZEMLJE - ARMATURA ZIDOVA, (ako nije drugačije naznačeno).

PREKLOP MREŽA a=45 cm

ZAŠTITNI SLOJ BETONA c=2,5 cm

BETON C25/30 ARMATURA B500B

ozn	oblik i mjera [cm]	Ø	lg [m]	n [kom]	lgn [m]
nomena (1 kom)					
1	800	14	6.00	5	30.00
2	400	14	5.00	3	15.00
3	600	14	6.00	8	48.00
4	200	14	2.20	14	30.80
5	200	14	2.50	10	25.00
6	120	10	1.20	61	73.20
7	110	12	1.20	16	19.20
8	120	10	2.50	116	290.00
9	60	8	1.36	315	428.40
10	270	12	3.70	6	28.60
11	280	12	2.90	4	11.60
12	60	6	1.32	65	85.80
13	600	12	6.00	5	30.00
14	300	8	3.00	108	318.00
16	400	10	4.00	42	168.00
16	15	12	1.22	200	244.00

Ø [mm]	lgn [m]	Jedinična težina [kg/m]	Težina [kg]
Ø 600			
8	832.20	0.40	328.72
10	631.20	0.62	327.75
12	334.40	0.89	296.95
14	148.80	1.21	180.05
Ukupno			1133.46

Oznaka mreže	B [cm]	L [cm]	n	Jedinična težina [kg/m²]	Ukupna težina [kg]
Q-335	215	600	21	5.28	1424.68
Q-188	215	600	16	2.98	610.94
Ukupno					2035.68

PRIZEMLJE- PLOČE

Br. revizije:	REVIZIJA	Datum revizije:
GLAVNI PROJEKTANT: Sanela Begonović, dipl.ing.arh. PROJEKTANT KONSTRUKCIJE: Branko Galic, dipl.ing.grad.	INVESTITOR: HRVATSKI CRVENI KRIZ Ulica Crvenog kriza 14-16, 10000 Zagreb OIB: 72527235659	IZVEDBENI GRAĐEVINSKI PROJEKT ZGRADA CENTRA HRVATSKOG CRVENOG KRIZA U KORISNIKESOCIJALNIH USLUGA U ZAJEDNICI Zagreb, Dubravkin trg 11 k.č.br. 277, k.o. Trnje
SURADNICI: Vlaho Miljanović, mag.ing.aedif. Toma Čurković, mag.ing.aedif. Lara Antulov-Fantulin, mag.ing.aedif.	SADRŽAJ: PRIZEMLJE - PLOČE	MJERILO: 1:50 BR.PR.-TD: 135/2020 DATUM: 02/2021 BR.NACRTA: 7

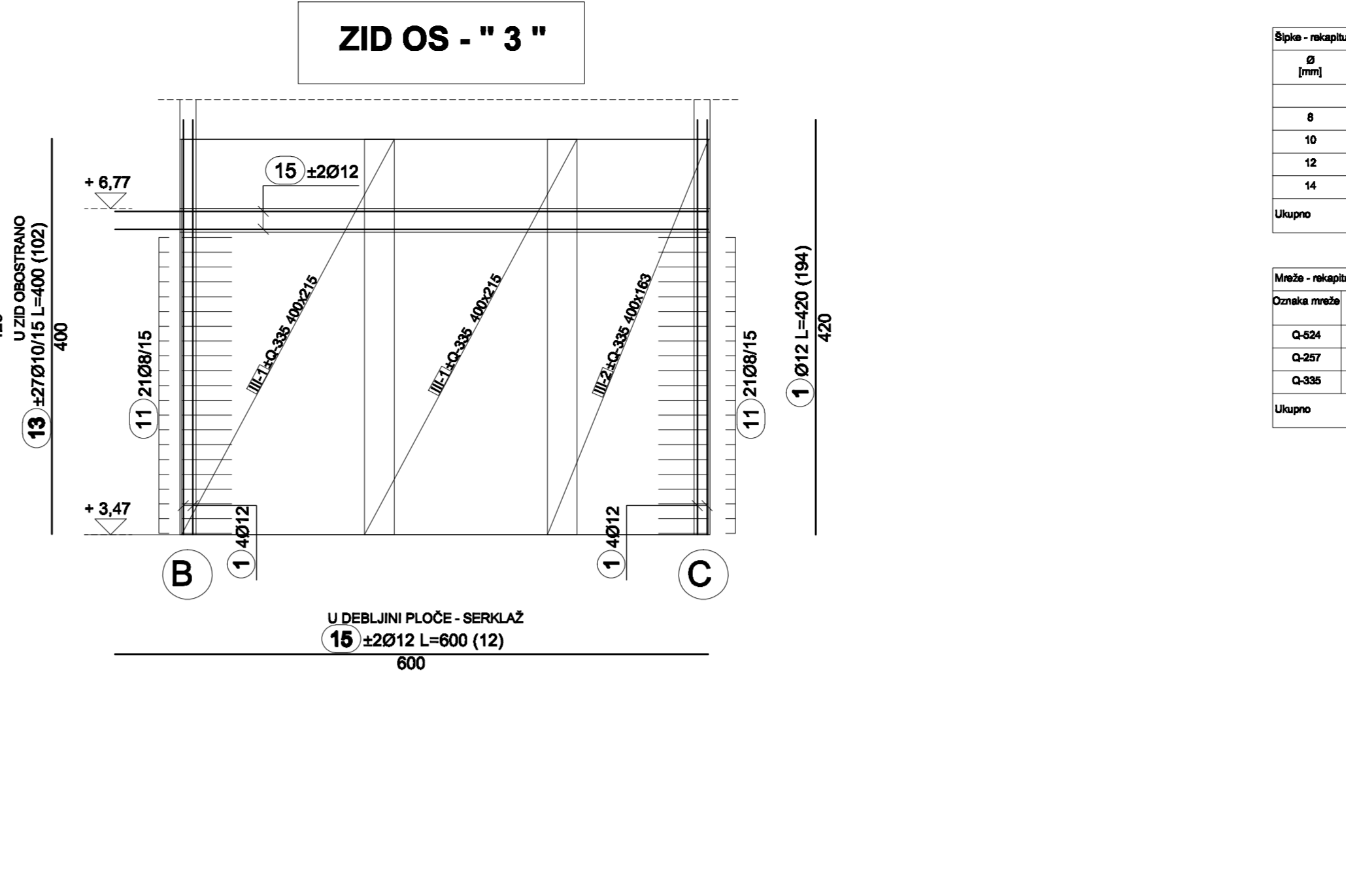
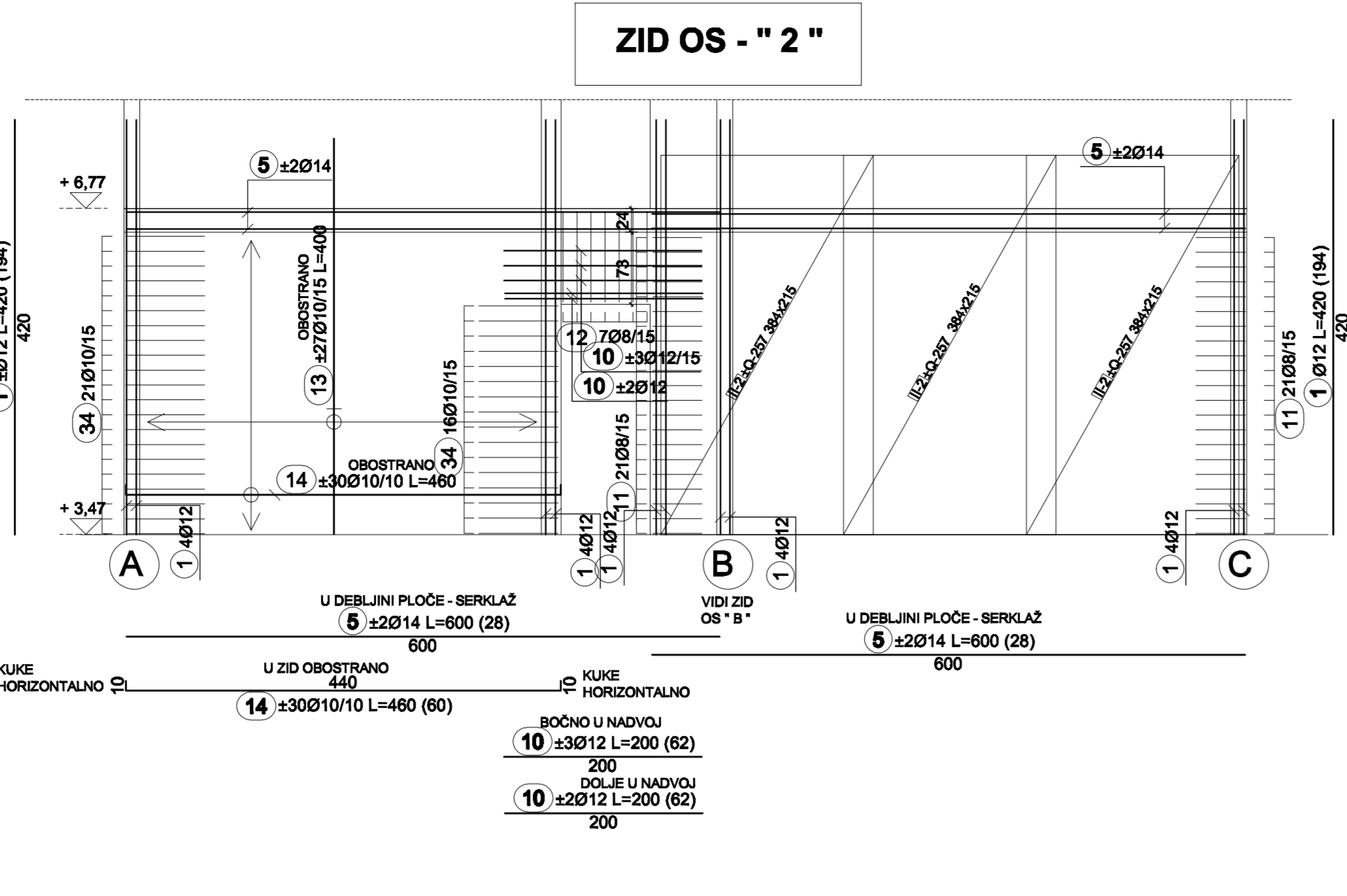
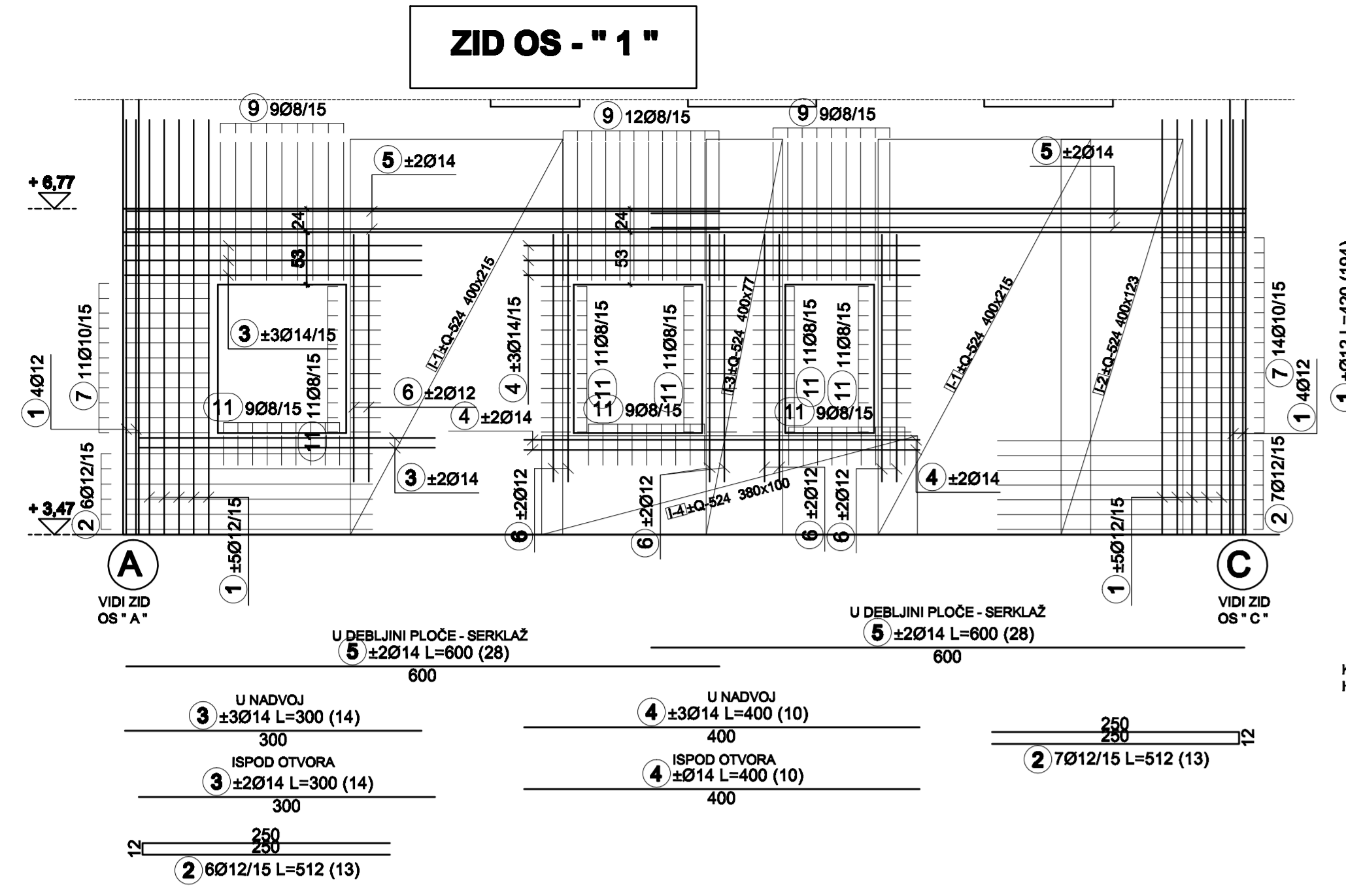

Bijela - rešetkasta			
Ø [mm]	lg [m]	Jedinična težina [kg/m]	Težina [kg]
8		8.00	
8	1264.78	0.40	499.59
10	1240.88	0.62	768.50
12	1408.16	0.86	1248.87
14	2068.80	1.21	2525.25
Ukupno			2899.01

Crna - rešetkasta			
Dimenzija mreže [mm]	Ø [mm]	L [m]	a [m]
G-304	215	800	7
G-207	215	800	28
G-338	215	800	17
Ukupno			52

Bijela - rešetkasta					
Ø [mm]	lg [m]	Ø [mm]	lg [m]	n [kom]	lg [m]
norma (1 kom)					
1	420	12	4.20	194	814.80
2	200	12	2.40	13	66.36
3	300	14	3.00	14	42.00
4	400	14	4.00	10	40.00
5	600	14	6.00	28	168.00
6	200	12	2.40	28	70.00
7	80	10	1.60	25	40.00
8	140	8	2.80	102	287.84
9	140	12	2.00	65	124.00
10	80	8	1.12	708	794.88
11	80	8	1.12	8	8.96
12	80	8	2.28	37	84.36
13	80	10	4.00	105	408.00
14	80	10	4.80	60	276.00
15	440	12	6.00	12	72.00
16	30	8	1.14	11	12.54
17	80	8	1.44	8	11.52
18	200	10	4.12	14	97.88
19	300	10	2.00	28	86.00
20	300	12	3.00	30	90.00
21	400	12	4.00	14	86.00
22	470	14	4.70	4	18.80
23	200	10	3.40	42	142.80
24	180	10	2.10	42	88.20
25	200	12	0.96	4	22.80
26	200	12	0.90	10	90.00
27	27	8	0.98	8	7.84
28	180	12	1.98	12	23.40
29	180	10	1.98	6	11.70
30	78	8	2.02	9	18.18
31	17	8	0.78	17	13.26
32	80	8	1.48	17	25.16
33	210	12	2.10	8	16.80
34	80	10	1.72	90	154.80

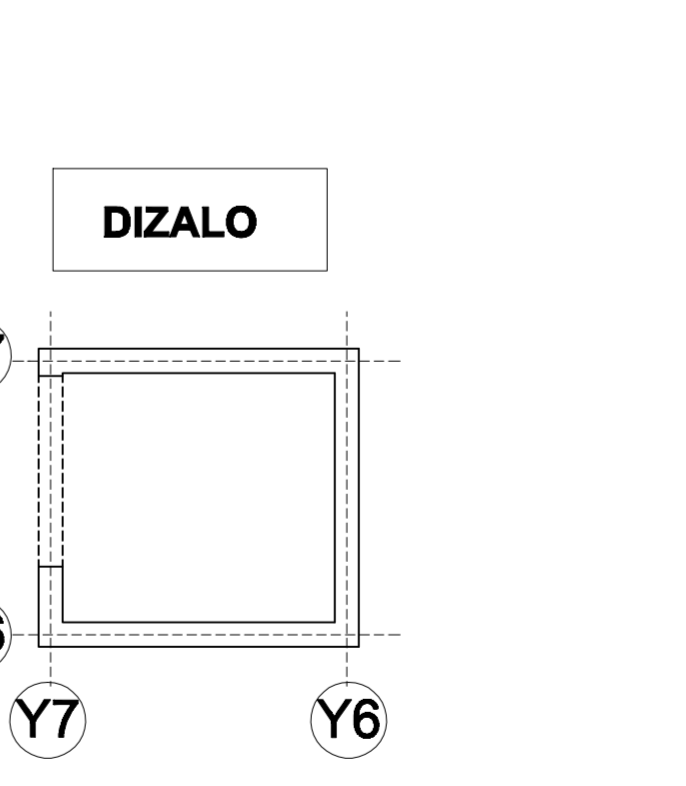
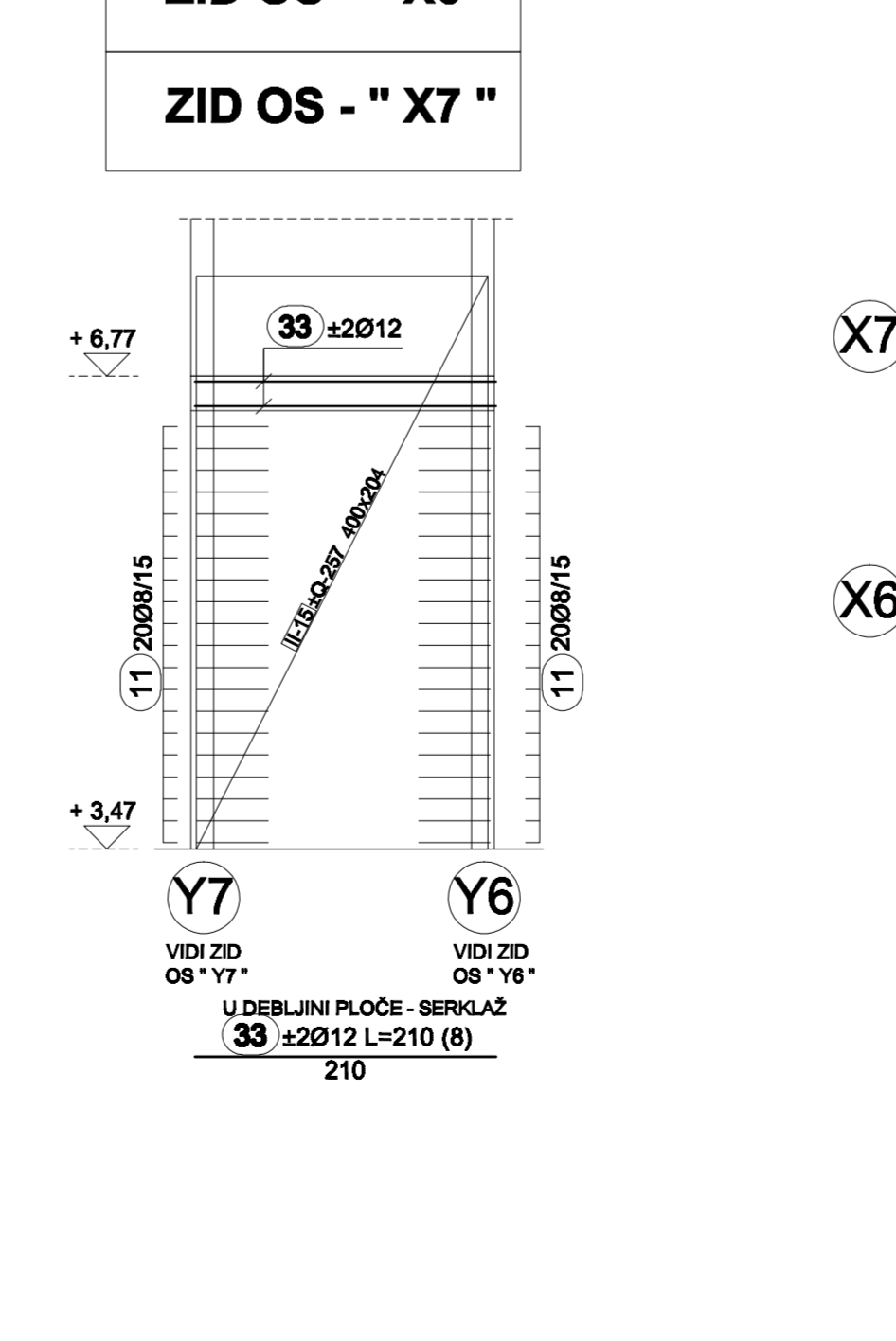
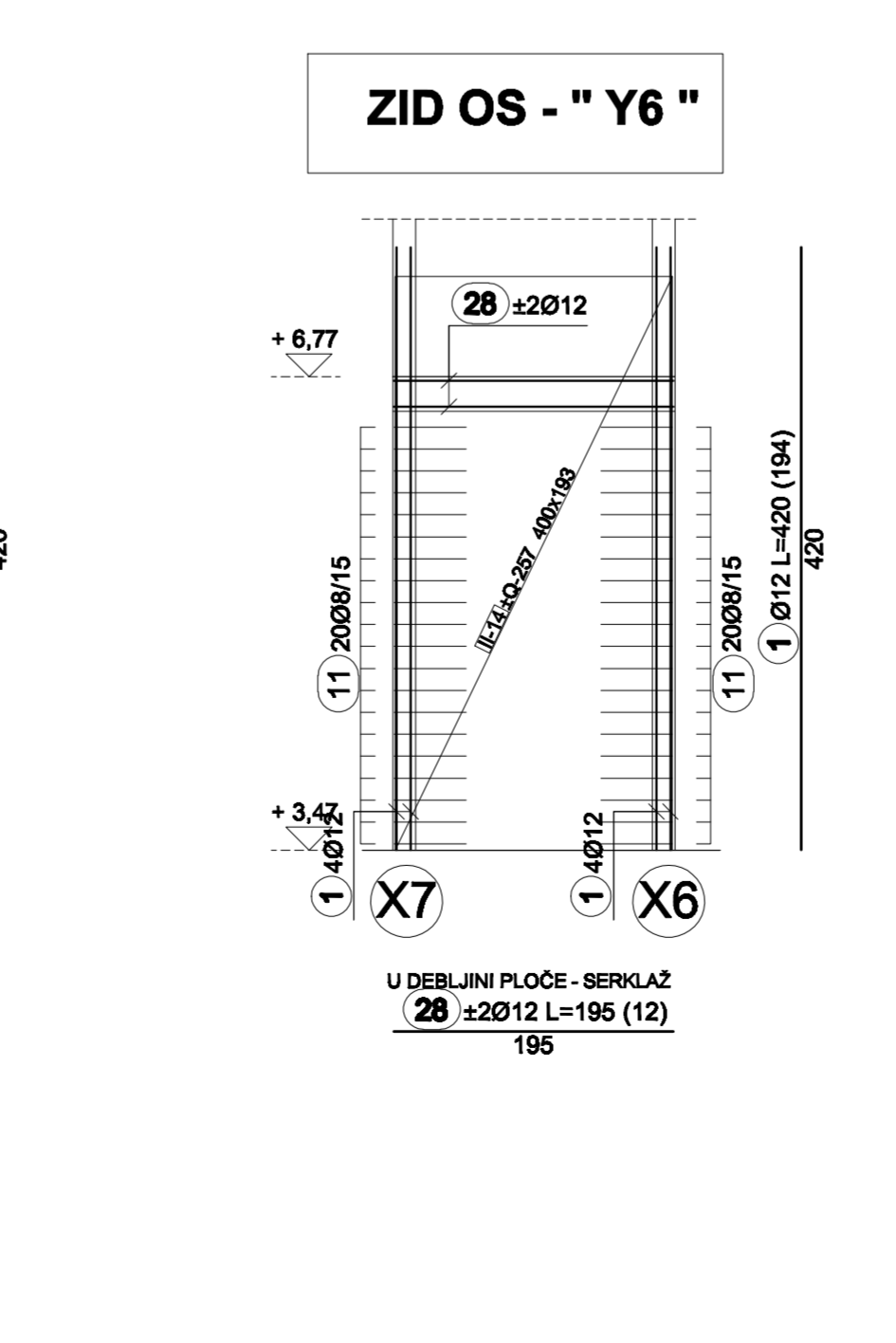
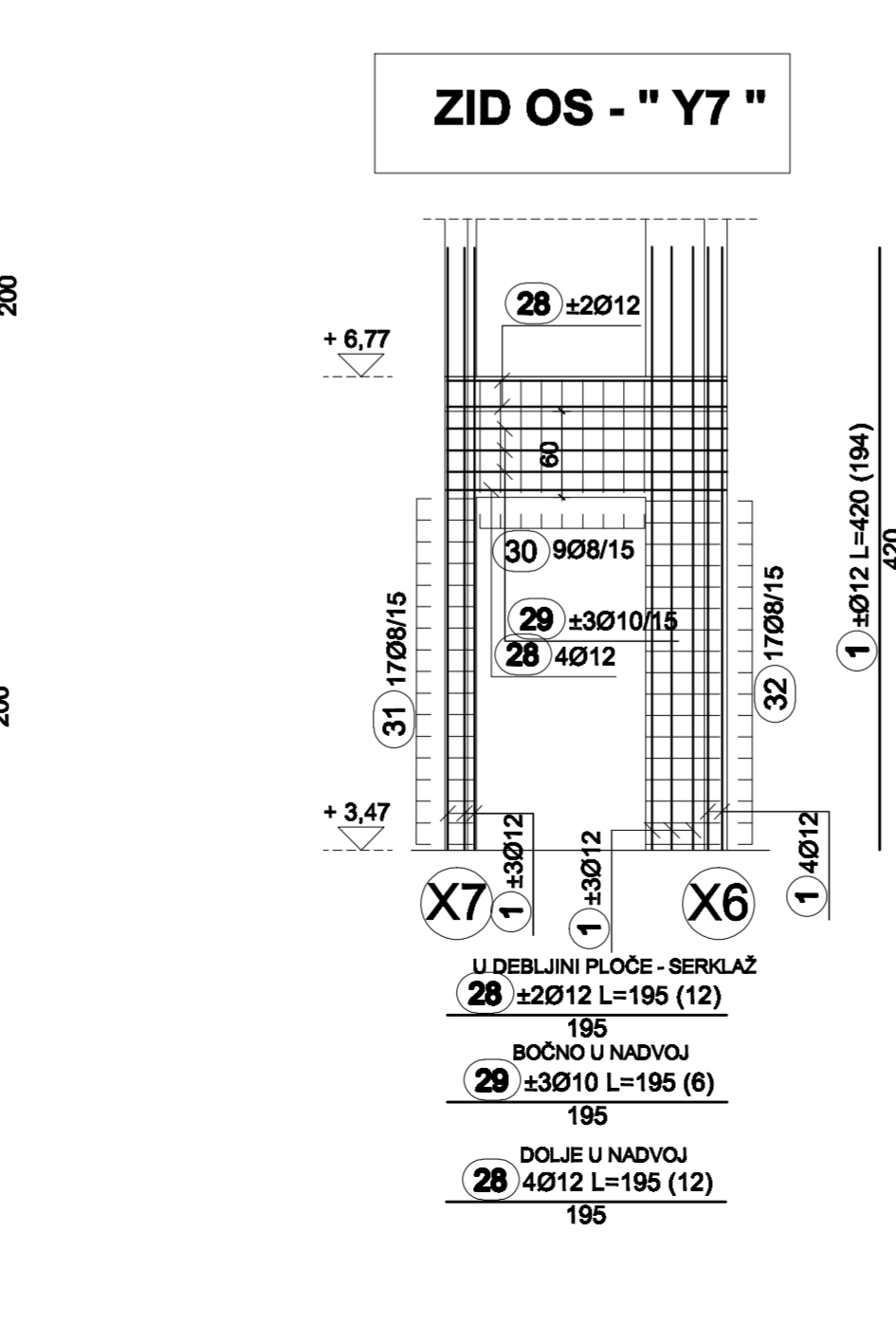
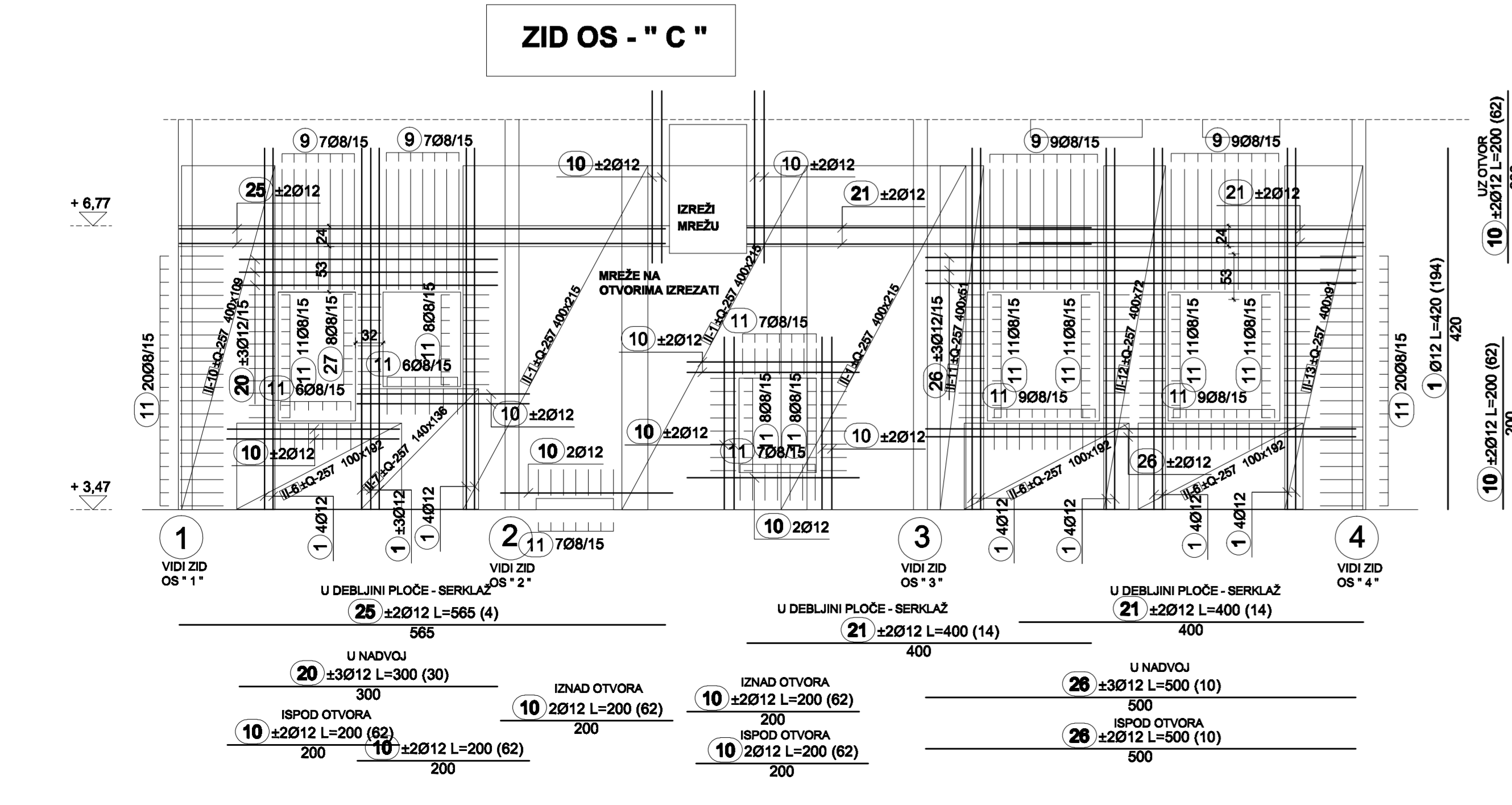
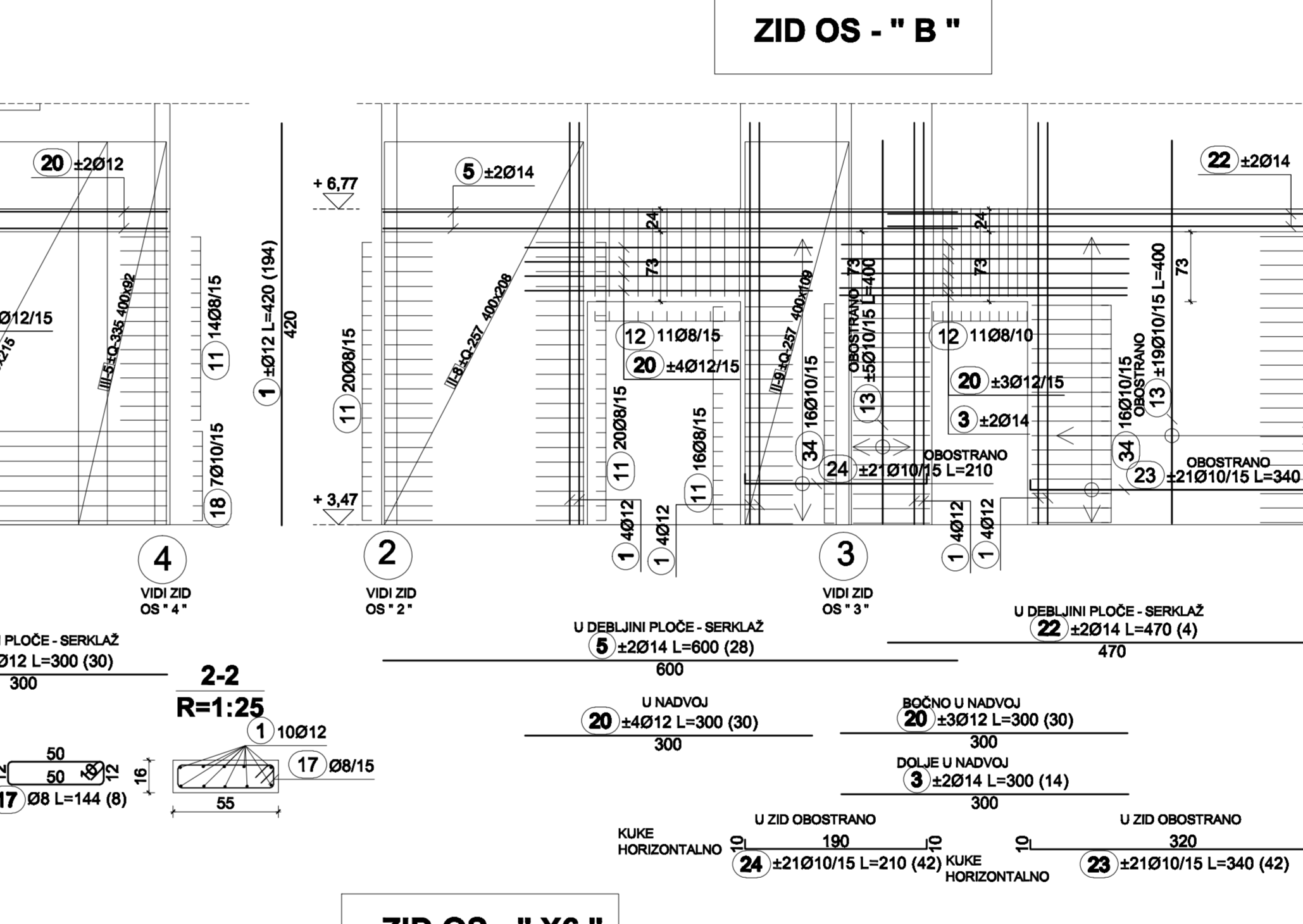
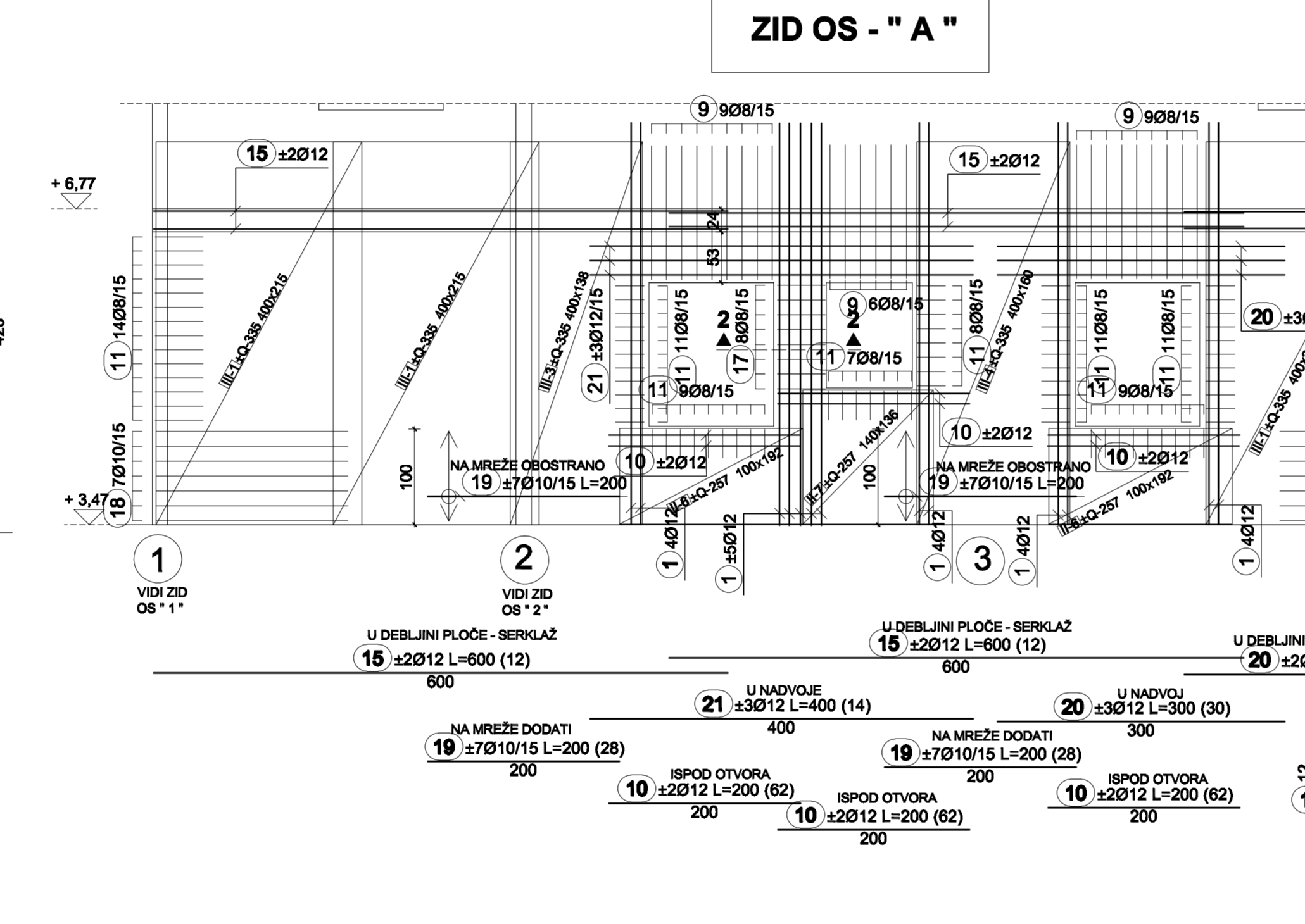
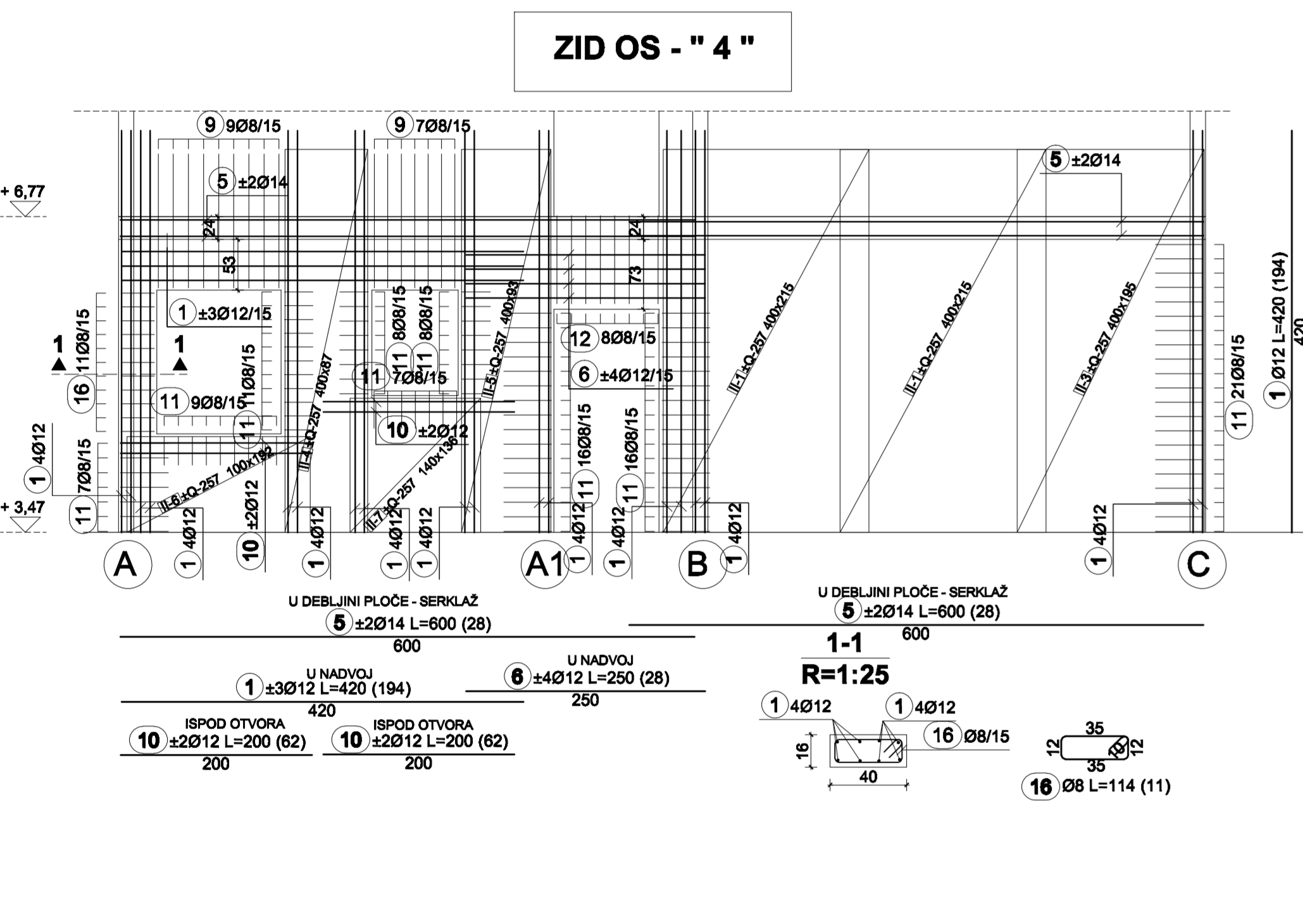

Napomena:
Prije betoniranja zidova OS 2, 3; i C vidi nastavke u armaturi stepenica List. 14.

VILICE IZ VANJSKIH ZIDOVA (GREDA)
U PLOČE - VIDI ARMATURU PLOČA

PREKLOP MREŽA
a= 30 cm

ZAŠTITNI SLOJ BETONA
c=2,0 cm

BETON C25/30
ARMATURA B500B

1. KAT - ZIDIVI

Br. revizije:	REVIZIJA	Datum revizije:
GLAVNI PROJEKTANT: PROJEKTANT KONSTRUKCIJE:	Sanela Begonović, dipl.ing.arh. Branko Galić, dipl.ing.grd.	INVESTITOR: HRVATSKI GRIVEN KRIZ Ulica Červinga izba 14-16, 10000 Zagreb OIB: 7282723599
SURADNICI:	Vahro Mijanović, mag.ing.aedf. Toma Čurković, mag.ing.aedf. Lara Anuškov-Fantulin, mag.ing.aedf.	ZORADA CENTRA HRVATSKOG CRVENOG KRIZA U ZORNENSKOSOCIALNIH USLUGA U ZAJEDNICI Zagreb, Dubravčin trg 11 t.fax: 01 277 5 61 79
SADRŽAJ:		1. KAT - ZIDIVI
MJERILO: 1:50		DATUM: 02/2021
BR.PR.TD 135/2020		BR.NACRTA: 8

DONJA ZONA

GORNJA ZONA

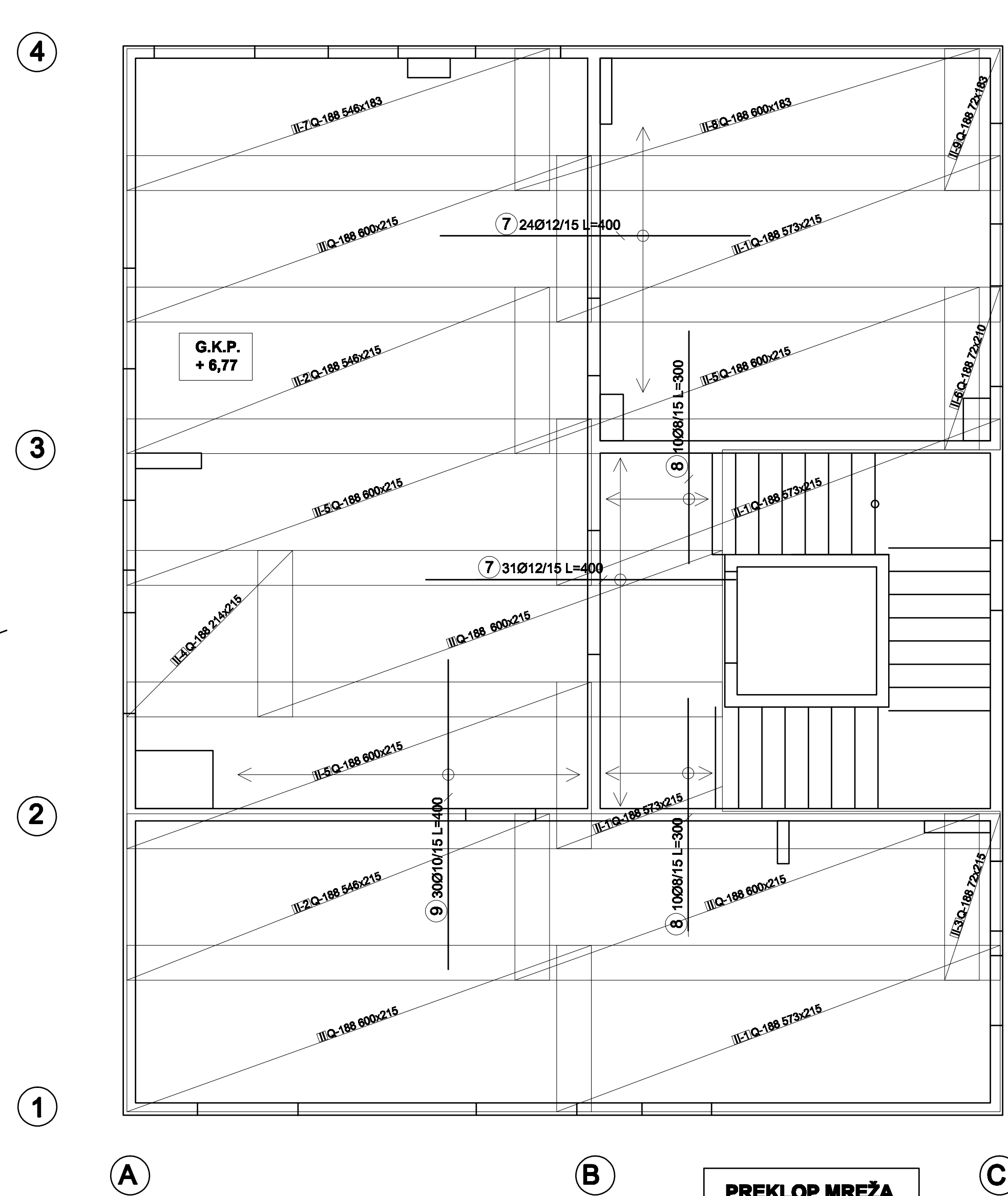
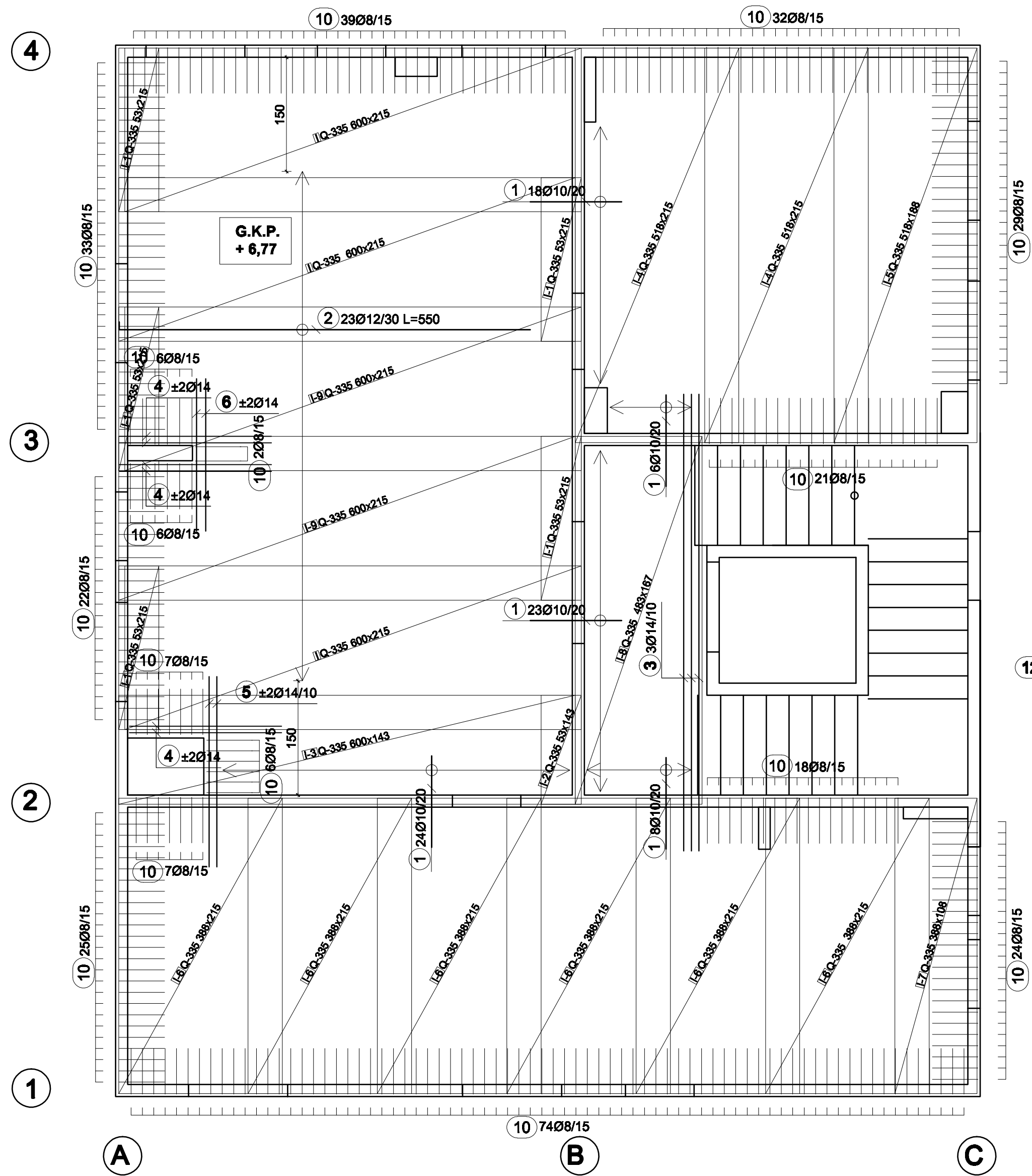

**JAHAIĆI
(DISTANCERI)**

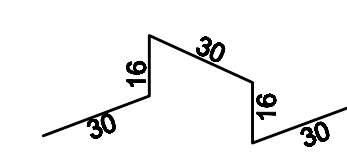

12 200Ø12 L=122 (200)

Šipka - specifikacija

ozn	oblik i mjera [cm]	Ø	lg [m]	n [kom]	lgm [m]
noname (1 kom)					
1	120	10	1.20	79	94.80
2	640	12	5.50	23	126.50
3	800	14	6.00	3	18.00
4	200	14	2.20	12	26.40
5	250	14	2.50	4	10.00
6	200	14	2.00	4	8.00
7	400	12	4.00	55	220.00
8	300	8	3.00	20	60.00
9	400	10	4.00	30	120.00
10	60	8	1.36	351	477.36
11	800	12	6.00	5	30.00
12		12	1.22	200	244.00

Šipka - rekapitulacija

Ø [mm]	lgm [m]	Jedinična težina [kg/m]	Težina [kg]
S 600			
8	537.36	0.40	212.28
10	214.80	0.82	132.53
12	620.50	0.89	551.00
14	62.40	1.21	75.50
Ukupno			971.30

Mreža - rekapitulacija

Oznaka mreže	B [cm]	L [cm]	n	Jedinična težina [kg/m ²]	Ukupna težina [kg]
Q-335	215	600	17	5.28	1153.52
Q-188	215	600	16	2.96	610.84
Ukupno					1764.46

**1. KAT
ARMATURA PLOČE**

Br. revizije:	REVIZIJA	Datum revizije:
---------------	----------	-----------------

 RADIONICA STATIKE d.o.o. Andrija Krčića 22, 10 000 Zagreb tel: +385 (0)20 20 444 fax: +385 (0)20 20 445 e-mail: radionica@statika.hr	INVESTITOR: HRVATSKI CRVENI KRIŽ Ulica Crvenog križa 14-16, 10000 Zagreb OIB: 72627253659
	GRAĐEVINA: ZGRADA CENTRA HRVATSKOG CRVENOG KRIŽA U KORISNIKESOCIJALNIH USLUGA U ZAJEDNICI
GLAVNI PROJEKTANT: Sanela Beganović, dipl.ing.arch.	LOKACIJA: Zagreb, Dubravkin trg 11 k.o.br. 277, k.o. Trnje
PROJEKTANT KONSTRUKCIJE: Branko Galić, dipl.ing.grad. 	FAZA PROJEKTA: IZVEDBENI GRAĐEVINSKI PROJEKT
SURADNICI: Vlaho Mijanović, mag.ing.aedif. Toma Čurković, mag.ing.aedif. Lara Antulov-Fantulin, mag.ing.aedif.	SADRŽAJ: 1. KAT PLOČE
	MJERILO: 1:50 DATUM: 02/2021 BR.PR.:TD 135/2020 BR.NACRTA: 9

RUBNA ARMATURA UZ SVE
OSTALE PRODORE U PLOČI

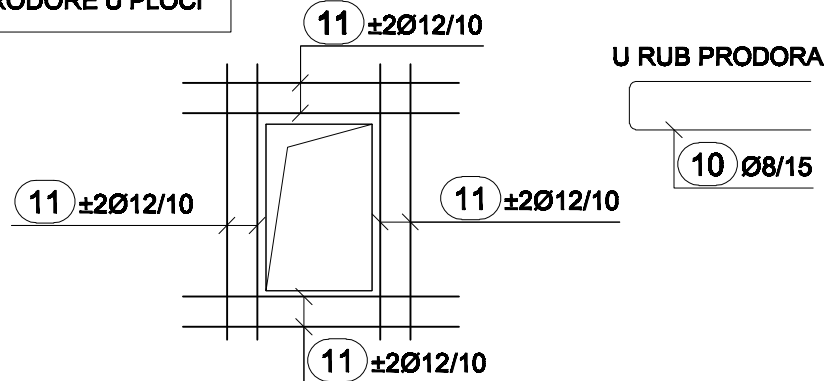

**- ARMATURU HORIZONTALNIH SERKLAŽA -
VIDI NACRT - 1. KAT - ARMATURA
ZIDOVA, (ako nije drugačije naznačeno).**

**PREKLOP MREŽA
a =45 cm**

**ZAŠITNI SLOJ BETONA
c=2,5 cm**

**BETON C25/30
ARMATURA B500B**

ZID OS - " 1 "

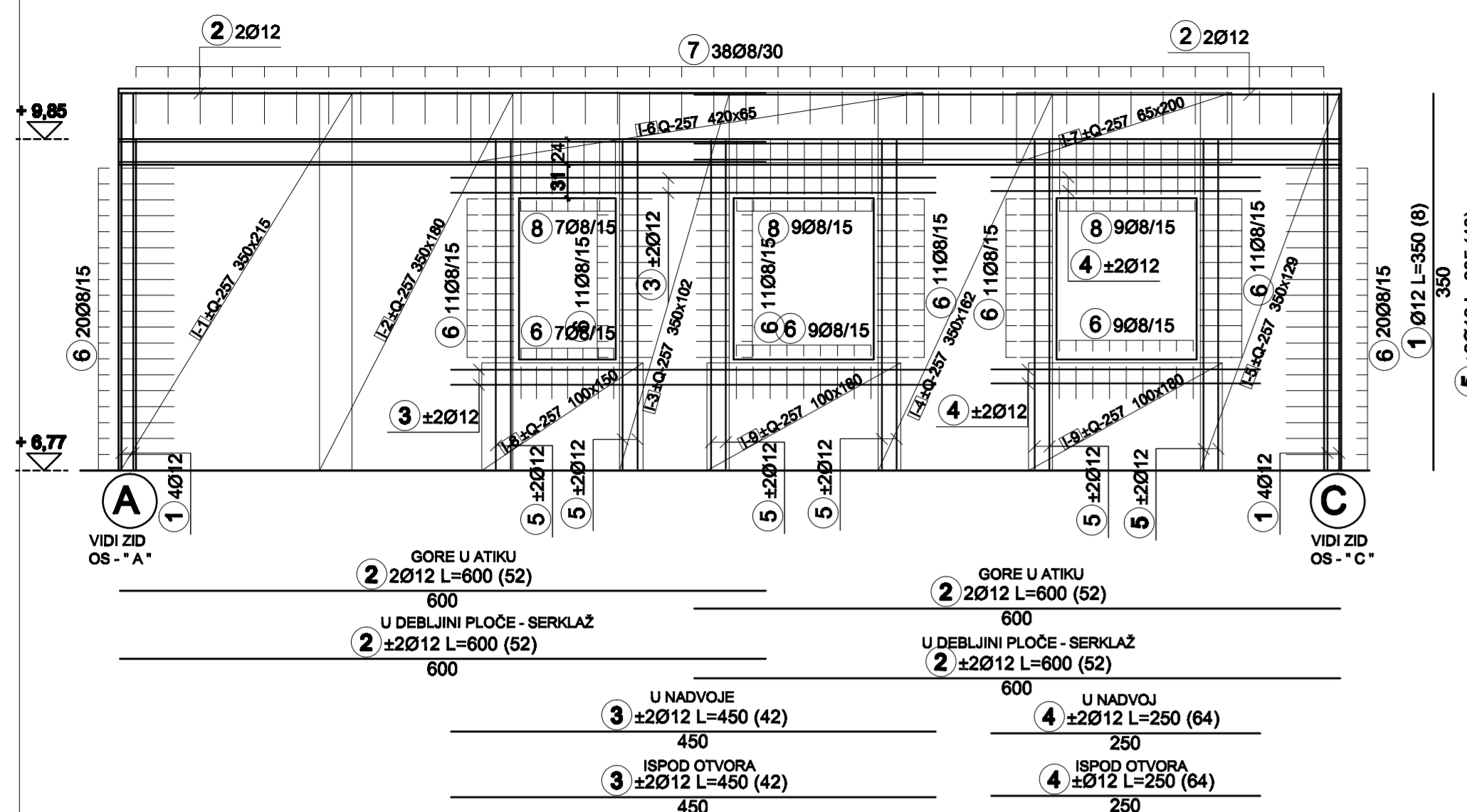

ZID OS - " 2 "

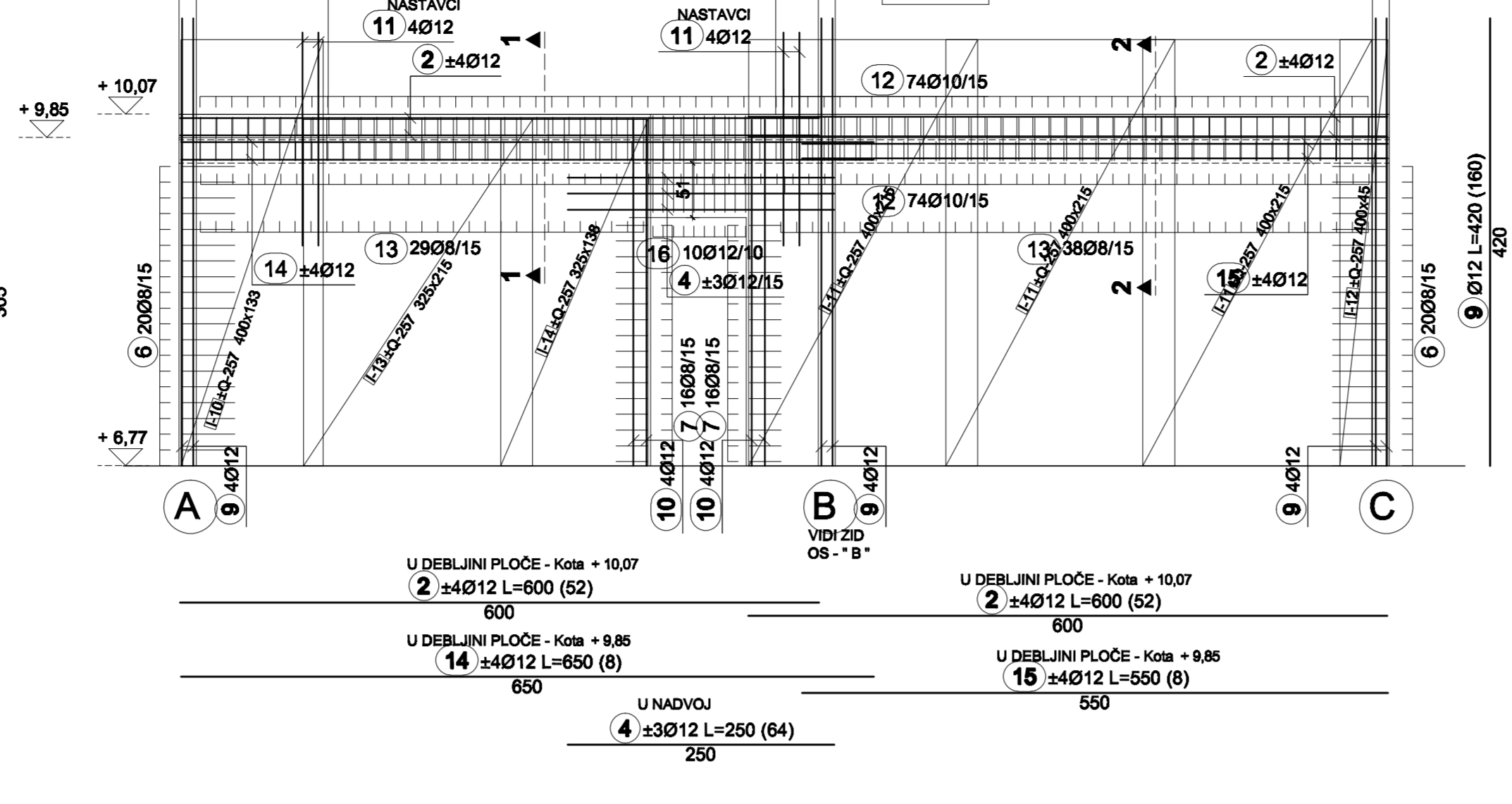

ZID OS - " 3 "

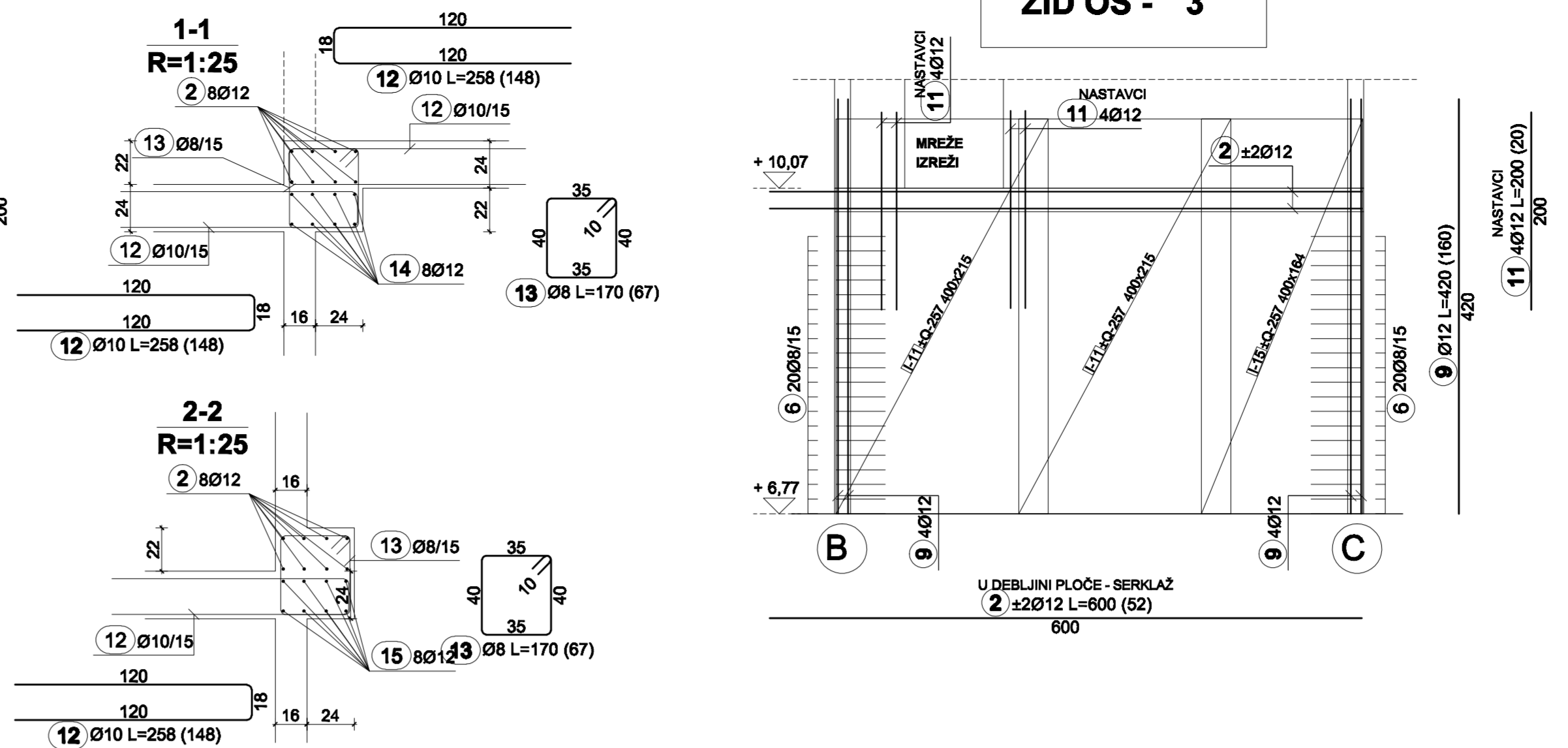

ZID OS - " 4 "

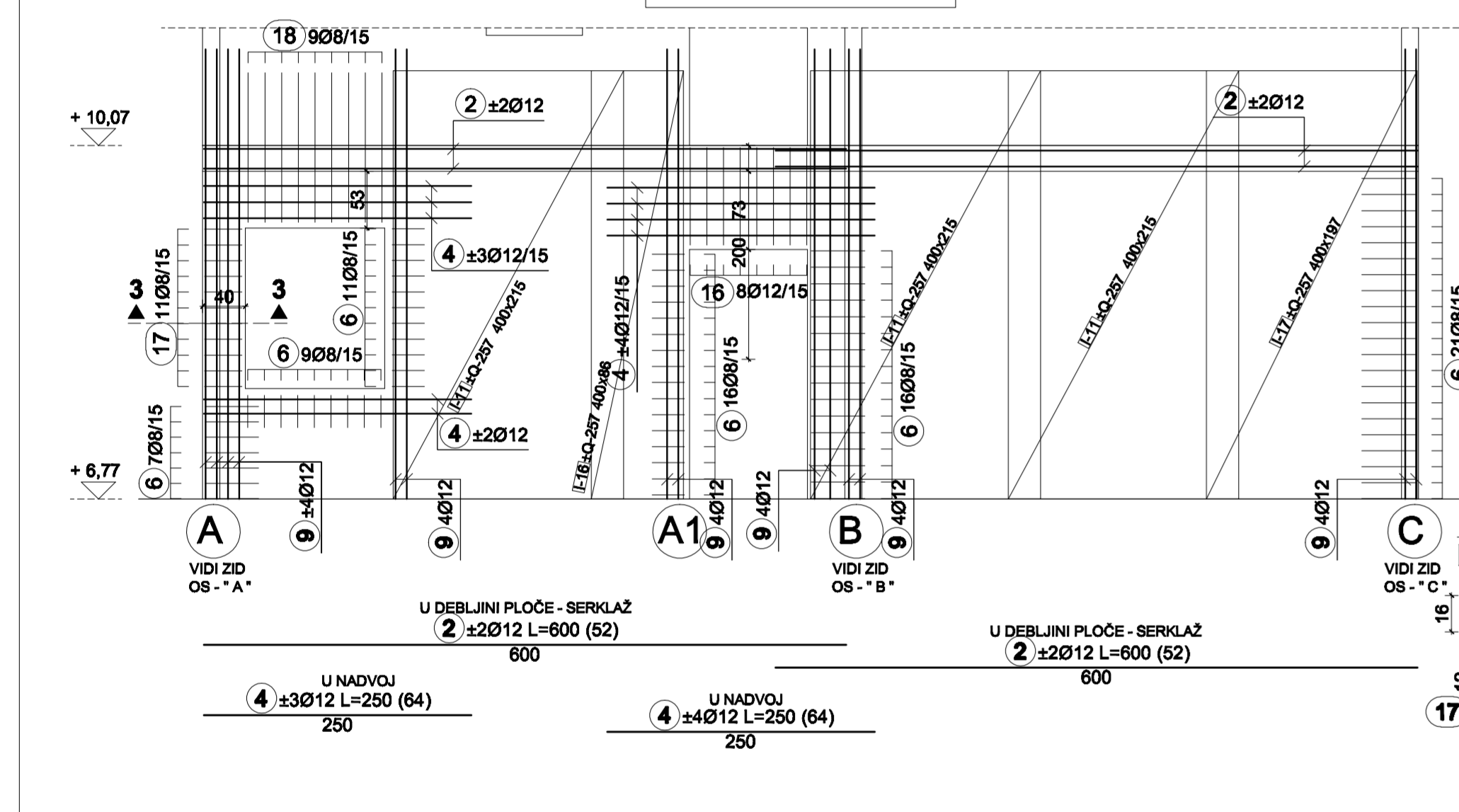

ZID OS - " A "

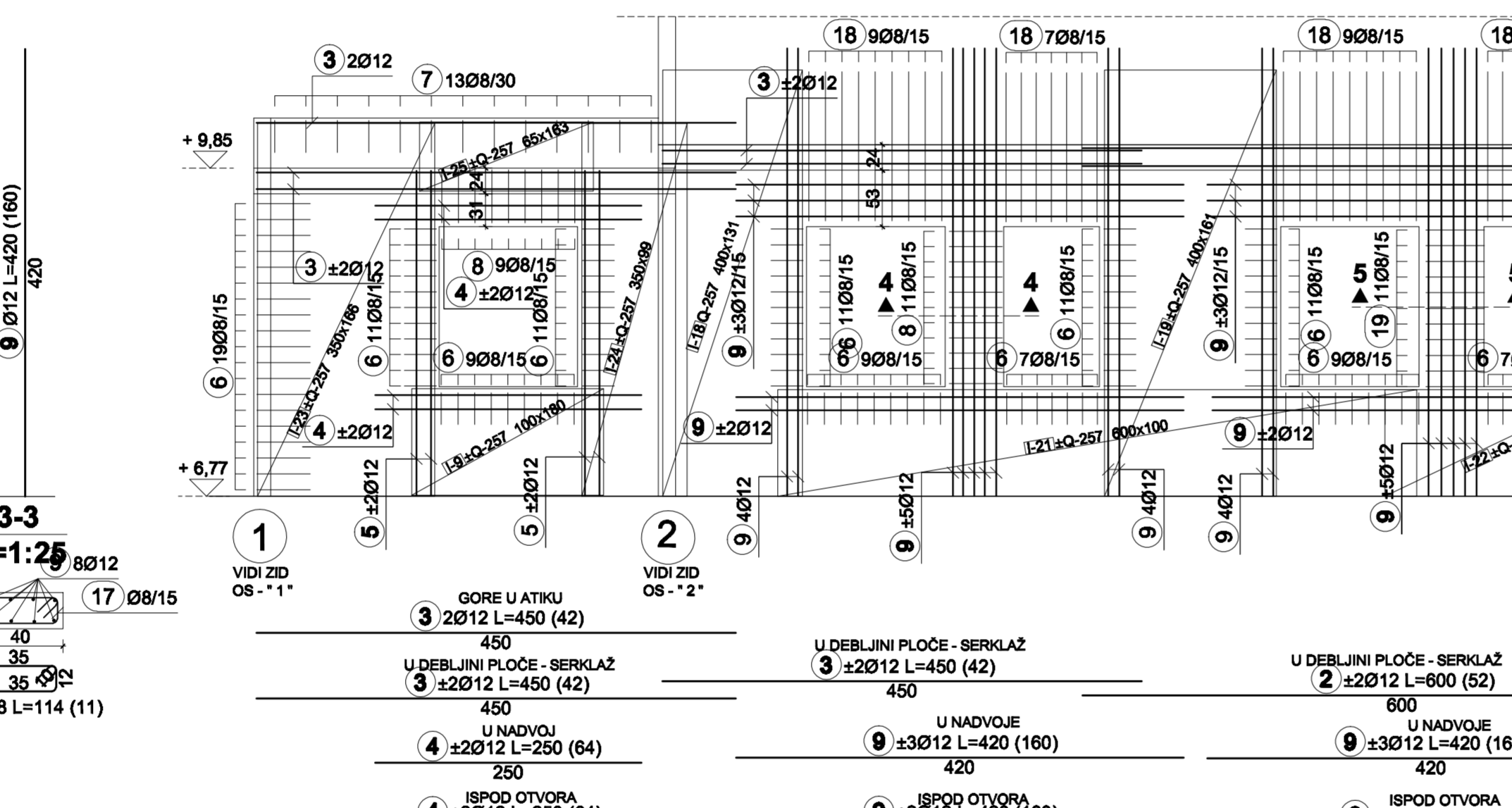

ZID OS - " B "

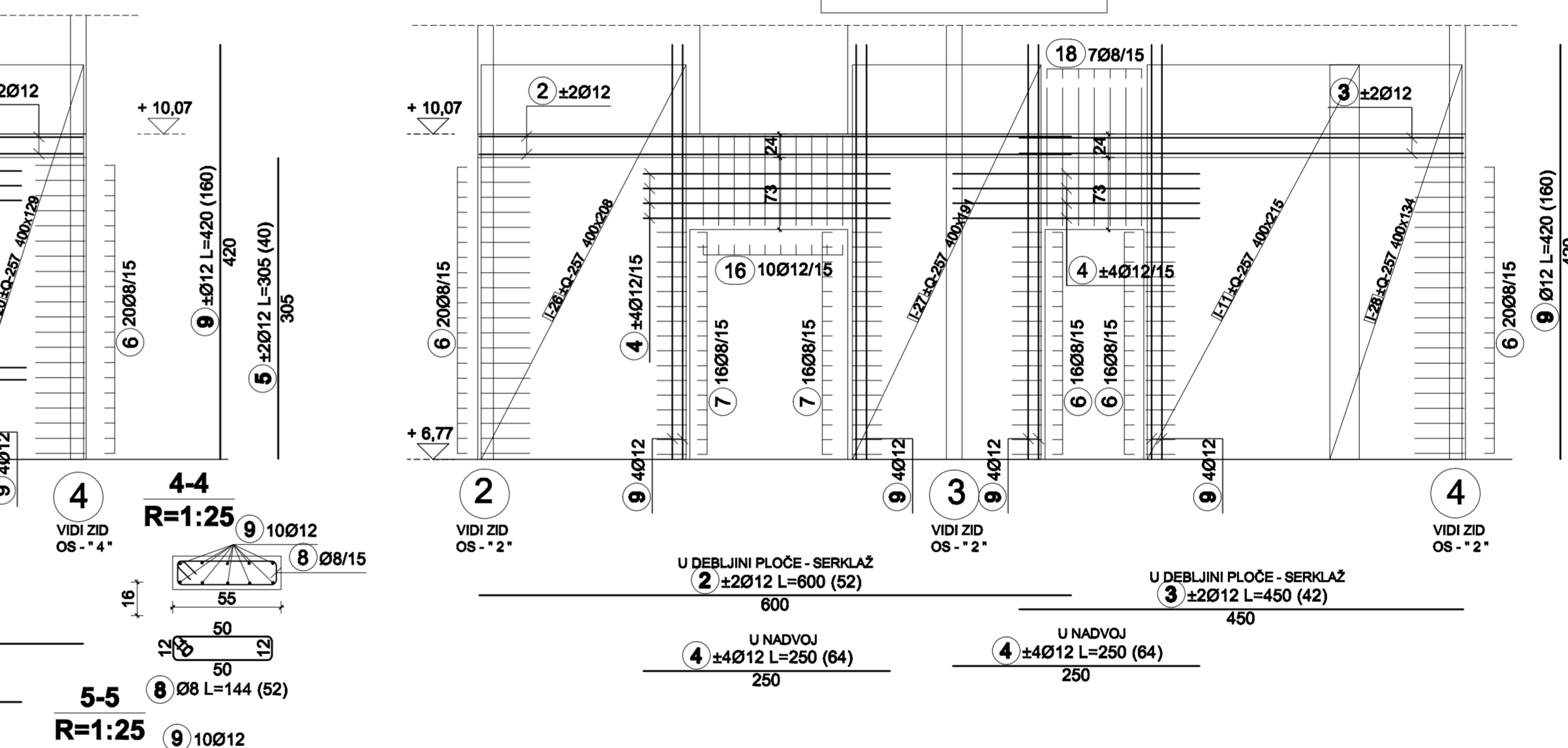

ZID OS - " C "

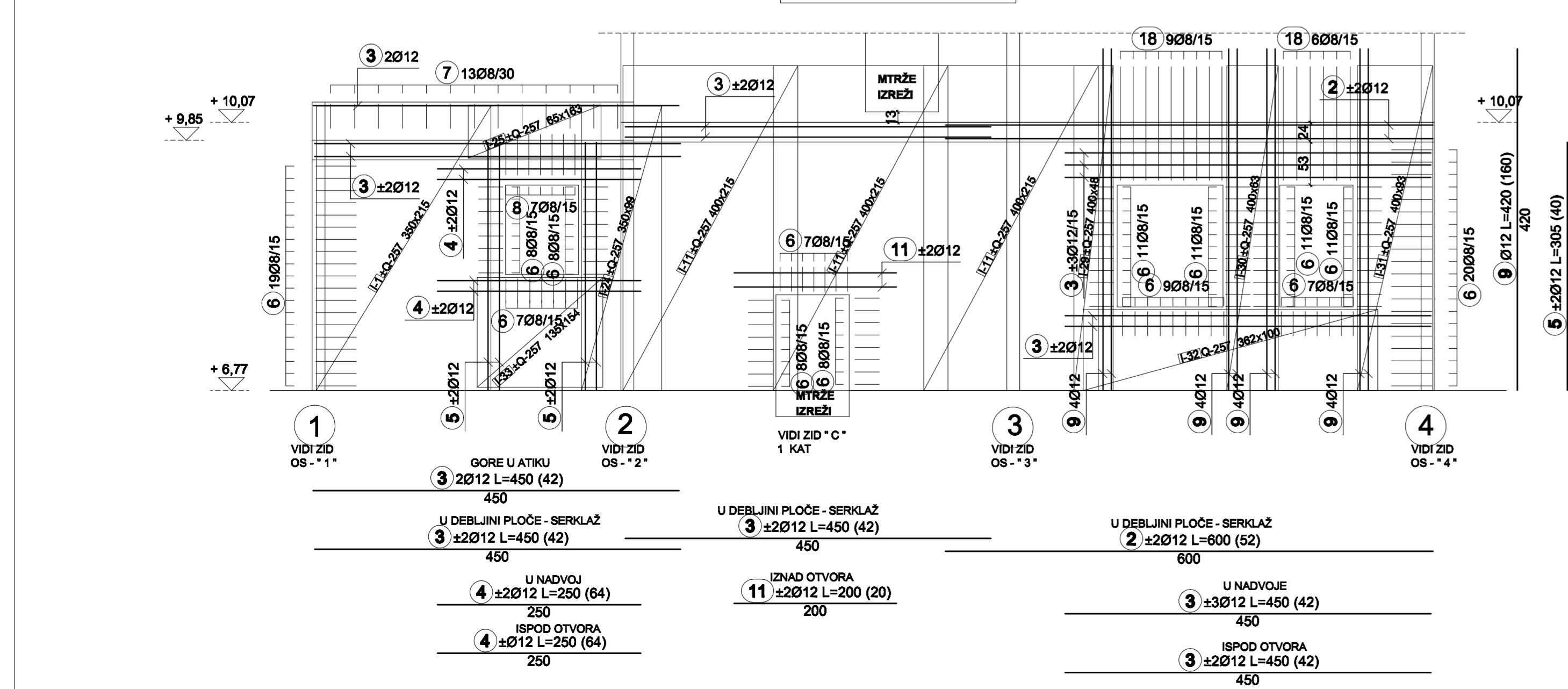

ZID OS - " Y7 "

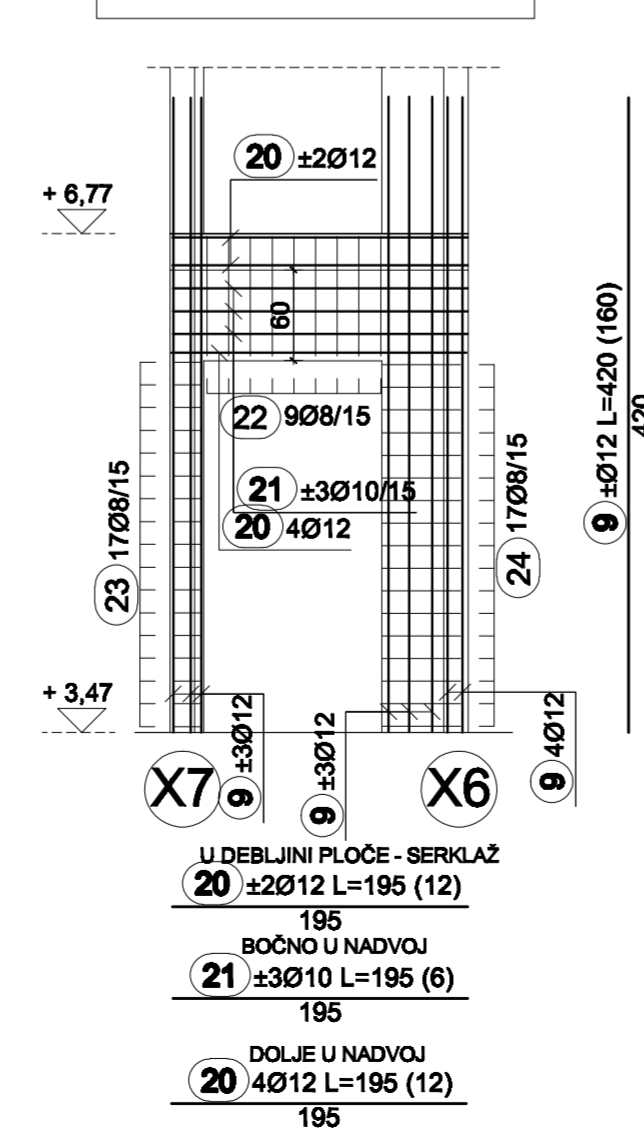

ZID OS - " Y6 "

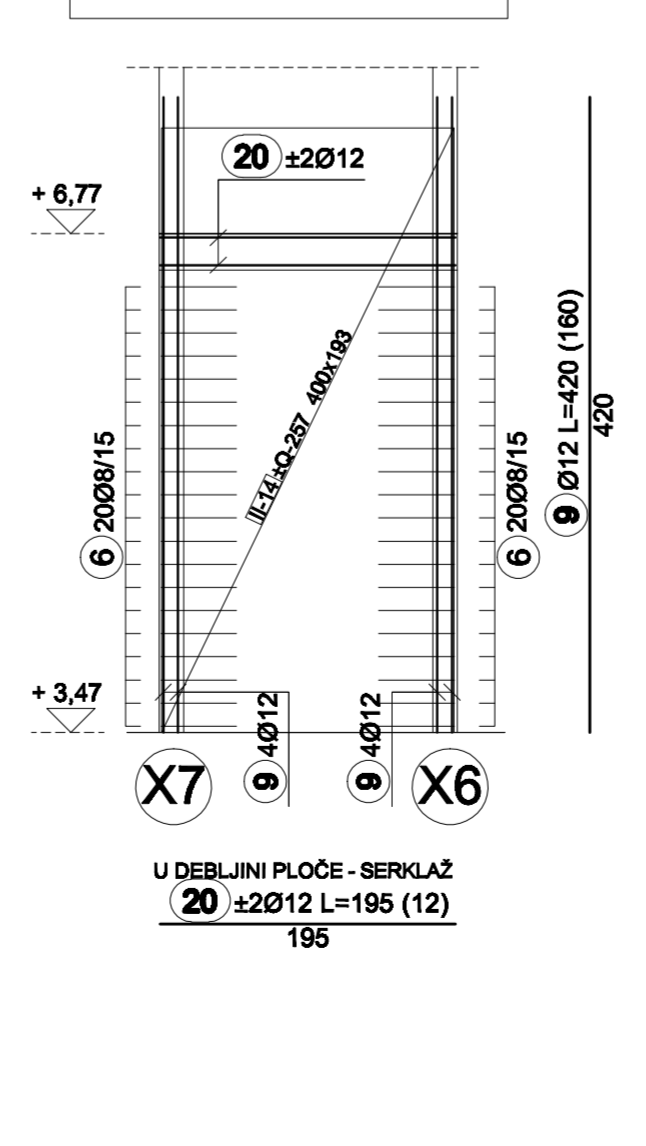

ZID OS - " X6 "

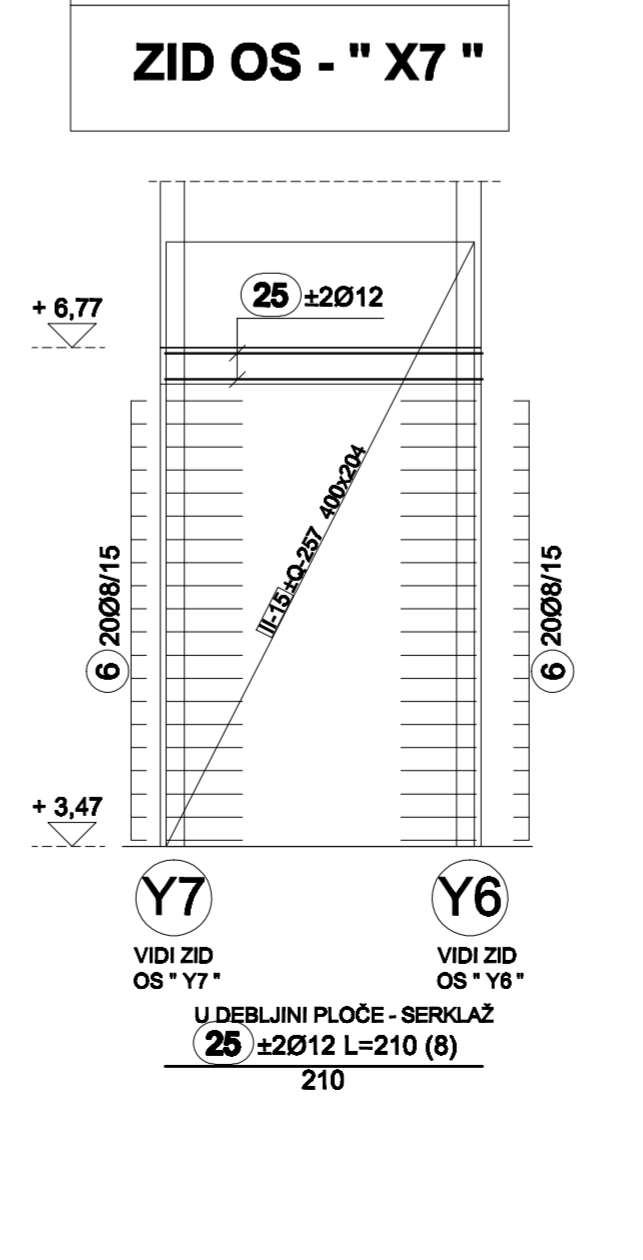

ZID OS - " X7 "

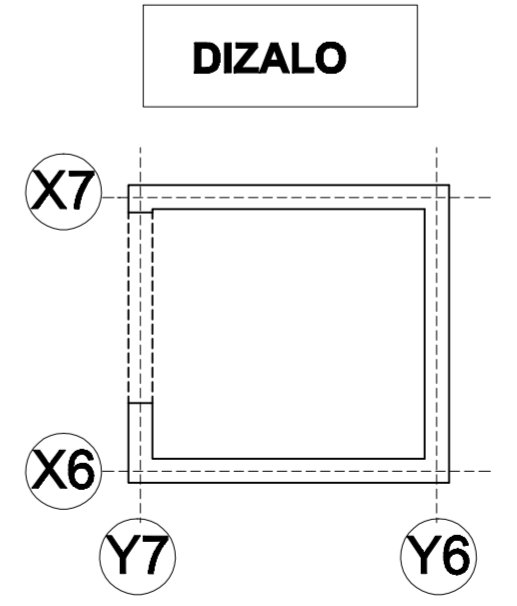

Napomena:
Prije betoniranja zidova OS 2; 3; i C, vidi nastavke u armaturi stepenica list. 14.

VILICE IZ VANJSKIH ZIDOVA (GREDA)
U PLOČE - VIDI ARMATURU PLOČA

PREKLOP MREŽA
a = 30 cm

ZAŠTITNI SLOJ BETONA
c=2,0 cm

BETON C25/30
ARMATURA B500B

**2. KAT
- ZIDOV I**

Šifra - specifikacija	oblik i mjera [mm]	0	1	2	3	4	5	6	7	8	9	10	11	12	13	14	15	16	17	18	19	20	21	22	23	24	25	
1	300	12	3,50	6	28,00																							
2	300	12	6,00	52	312,00																							
3	300	12	4,50	42	189,00																							
4	300	12	2,50	64	160,00																							
5	300	12	3,00	40	120,00																							
6	300	6	1,12	774	896,88																							
7	300	6	0,72	138	102,16																							
8	300	6	1,44	52	74,88																							
9	300	12	4,20	160	672,00																							
10	300	12	3,25	8	26,00																							
11	300	12	2,00	20	40,00																							
12	300	10	2,58	148	381,84																							
13	300	6	1,70	67	113,90																							
14	300	12	6,00	8	52,00																							
15	300	12	5,00	8	44,00																							
16	300	12	2,28	28	63,84																							
17	300	6	1,14	11	12,54																							
18	300	6	2,92	63	183,96																							
19	300	6	1,54	11	16,94																							
20	300	12	1,95	12	23,40																							
21	300	10	1,95	6	11,70																							
22	300	6	2,02	9	18,18																							
23	300	6	0,78	17	13,26																							
24	300	6	1,48	17	25,16																							
25	300	12	2,10	8	16,80																							

Šifra - specifikacija	lg [m]	Jedinična težina [kg/m]	Težina [kg]
6	1417,80	0,40	567,12
8	385,54	0,82	316,34
10	1748,40	0,88	1528,59
Ukupno			2382,05

Mjesta - raspodjela	B [m]	L [m]	n	Jedinična težina [kg/m]	Ukupna težina [kg]
0-207	216	600	70	4,02	3050,08
Ukupno					3050,08

Br. revizije: _____ REVIZIJA _____ Datum revizije: _____

RADIONICA STATIKE d.o.o. INVESTITOR: HRVATSKI CRVENI KRŽ
 Ulica Čerinskog br.14-16, 10000 Zagreb
 OIB: 7262720869

PROJEKTANT: Sanjka Beganović, dipl.ing. arh. GRAĐEVINA: ZGRADA CENTRA HRVATSKOG
 KONSTRUKCIJE: Branislav Gelić, dipl.ing. grad. KORIŠNENJE: SOCIJALNIH USLUGA U
 ZAJEDNICI

LOKACIJA: Zagreb, Dubravkinog trg 11
 k.č. 1/207/277, k.č. 1/207/277

FAZA PROJEKTA: IZVEDBENI GRAĐEVINSKI PROJEKT

SURADNICI: Vahjo Mijanović, mag.ing.aseof. SADRŽAJ: 2. KAT - ZIDOV I

MAJERLO: 1:50 DATUM: 02/2021
 Lana Anušić-Fanulin, mag.ing.aseof. BR.PRJ.TD 135/2020 BR.NACRTA: 10

DONJA ZONA

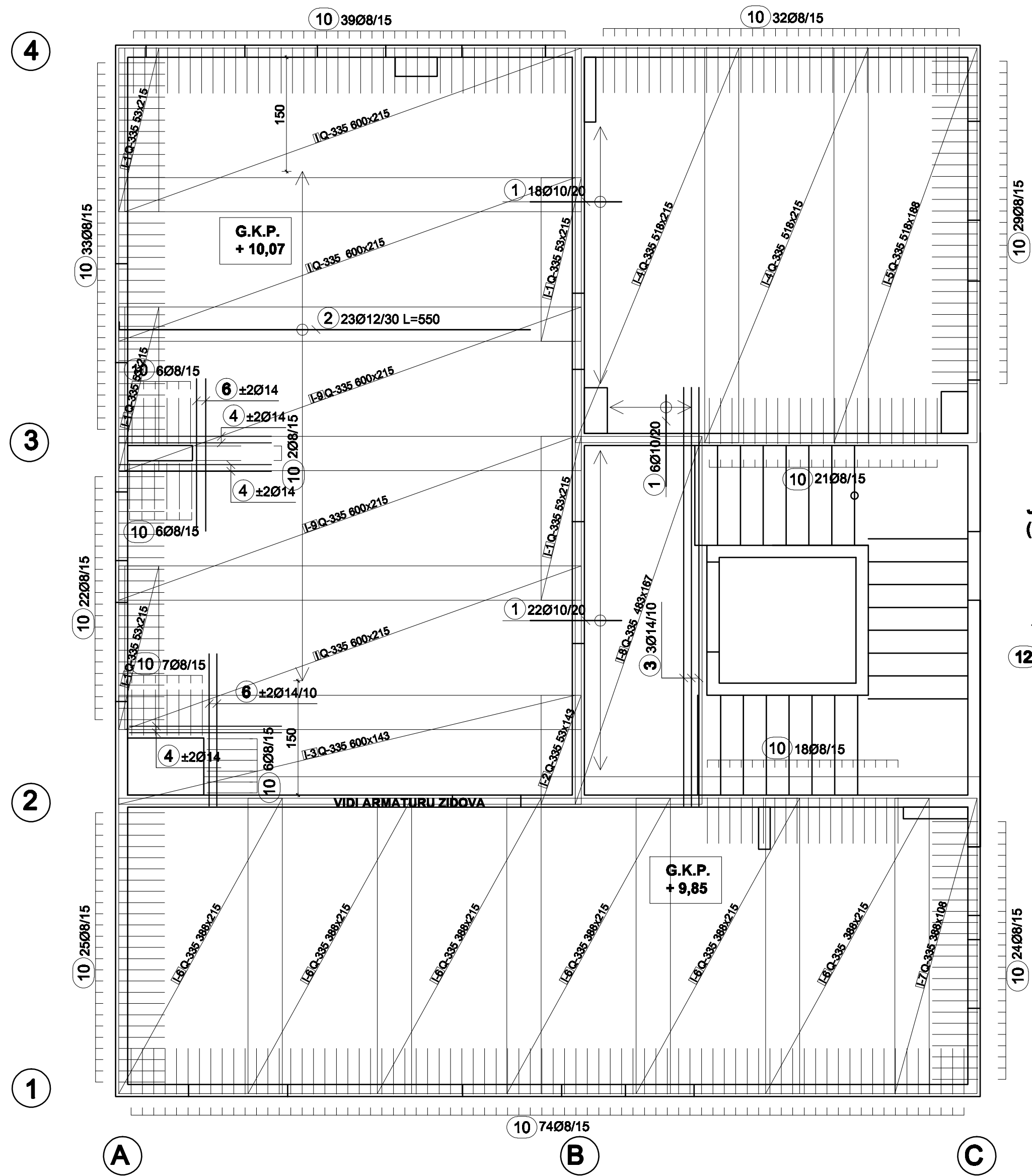

JAHAČI
(DISTANCERI)

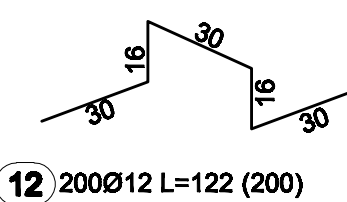

RUBNA ARMATURA UZ SVE
OSTALE PRODORE U PLOČI

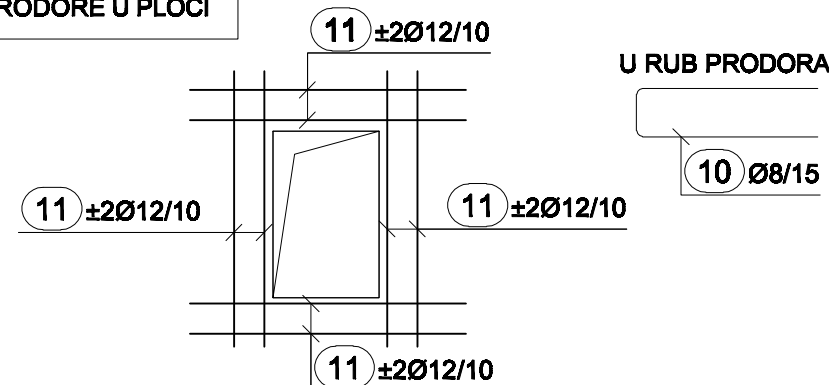

GORNJA ZONA

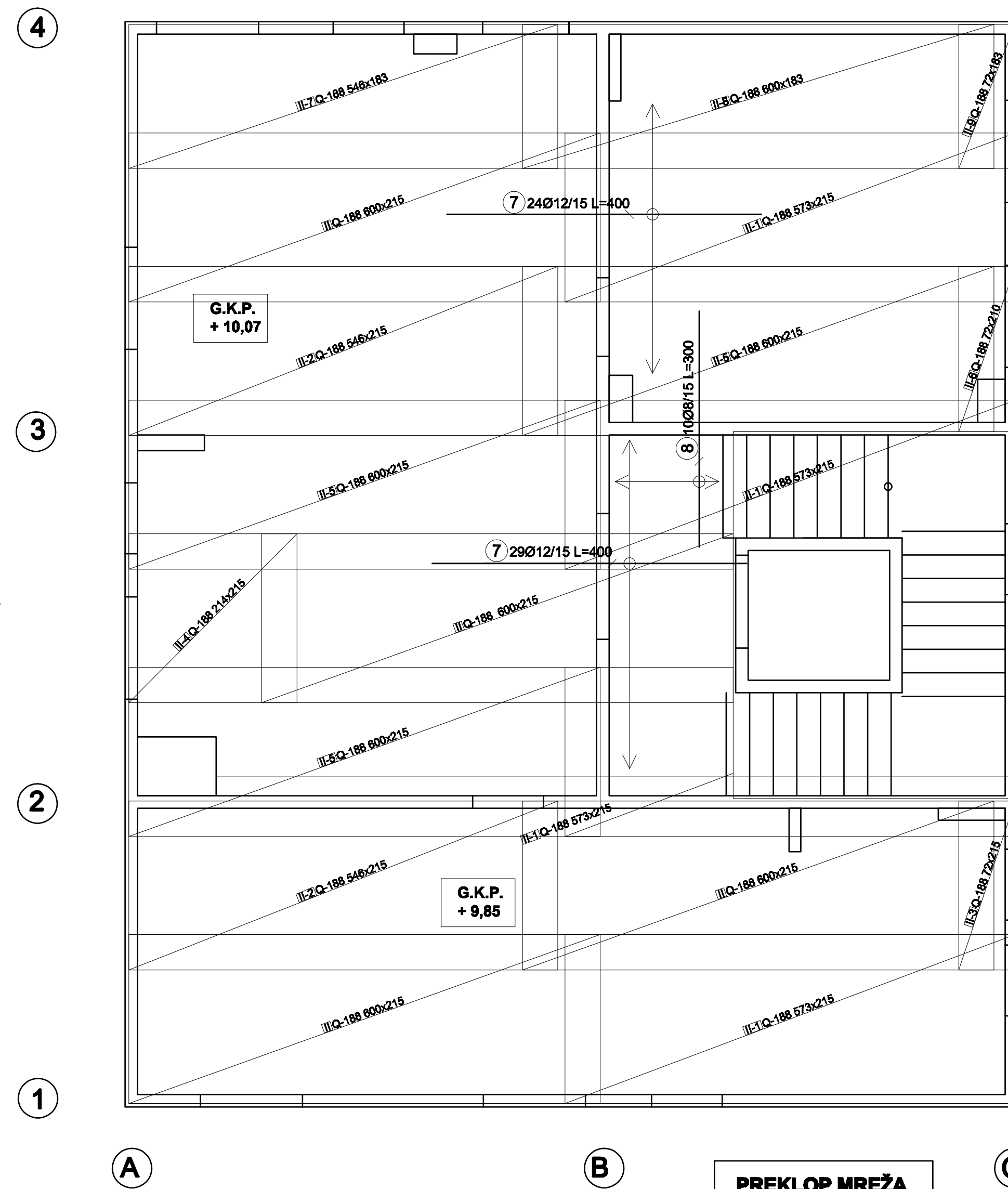

- ARMATURU HORIZONTALNIH SERKLAŽA -
VIDI NACRT - 2. KAT - ARMATURA
ZIDOVA, (ako nije drugačije naznačeno).

PREKLOP MREŽA
a = 45 cm

ZAŠITNI SLOJ BETONA
c=2,5 cm

BETON C25/30
ARMATURA B500B

Šipke - specifikacija						
ozn	oblik i mjera [cm]	Ø	lg [m]	n [kom]	lgn [m]	
nomena (1 kom)						
1	120	10	1,20	46	55,20	
2	150	12	5,50	23	126,50	
3	540	14	5,50	3	16,50	
4	200	14	2,20	12	26,40	
6	200	14	2,00	8	16,00	
7	400	12	4,00	53	212,00	
8	300	8	3,00	10	30,00	
10	60	8	1,38	344	467,84	
11	600	12	6,00	5	30,00	
12	28 10 28 10 27 12 16 20 28 10	12	1,22	200	244,00	

Šipke - rekapitulacija				
Ø [mm]	lgn [m]	Jedinična težina [kg/m]	Težina [kg]	
		8 800		
8	497,84	0,40	199,15	
10	55,20	0,62	34,06	
12	612,50	0,89	543,90	
14	58,90	1,21	71,27	
Ukupno			1845,87	

Mreža - rekapitulacija					
Oznaka mreže	B [cm]	L [cm]	n	Jedinična težina [kg/m²]	Ukupna težina [kg]
Q-335	215	600	17	6,28	1153,52
Q-188	215	600	16	2,96	610,94
Ukupno					1764,46

2. KAT ARMATURA PLOČE

Br. revizije:	REVIZIJA	Datum revizije:
RADIONICA STATIKE d.o.o. Andrija Kačić Miošića 22, 10 000 Zagreb tel: +385 (0)20 20 444 fax: +385 (0)20 20 445 e-mail: radionica@statika.hr		
GLAVNI PROJEKTANT: Sanela Beganović, dipl.ing.arh. PROJEKTANT KONSTRUKCIJE: Branko Galčić, dipl.ing.grad. 	INVESTITOR: HRVATSKI CRVENI KRIŽ Ulica Crvenog križa 14-16, 10000 Zagreb OIB: 72527253650 GRAĐEVINA: ZGRADA CENTRA HRVATSKOG CRVENOG KRIŽA U KORISNIKESOCIJALNIH USLUGA U ZAJEDNICI LOKACIJA: Zagreb, Dubravčin trg 11 k.č.br. 277, k.o. Trnje FAZA PROJEKTA: IZVEDBENI GRAĐEVINSKI PROJEKT SADRŽAJ: 2. KAT PLOČE	SURADNICI: Vlaho Miljanović, mag.ing.aedif. Tomo Čurković, mag.ing.aedif. Lara Antulov-Fantulin, mag.ing.aedif.
MJERILO: 1:50	DATUM: 02/2021	BR.PR.:TD 135/2020
BR.NACRTA: 11		

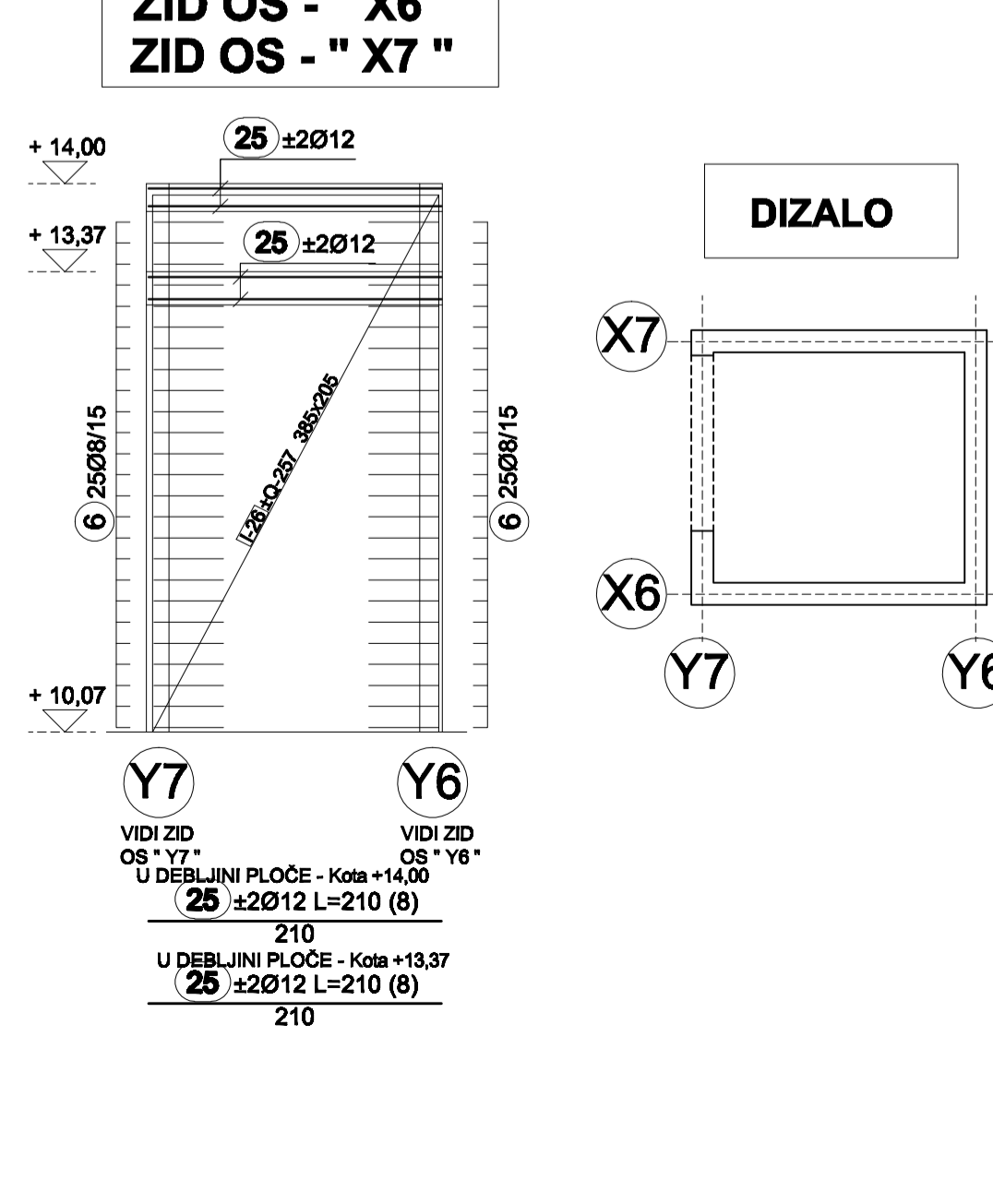
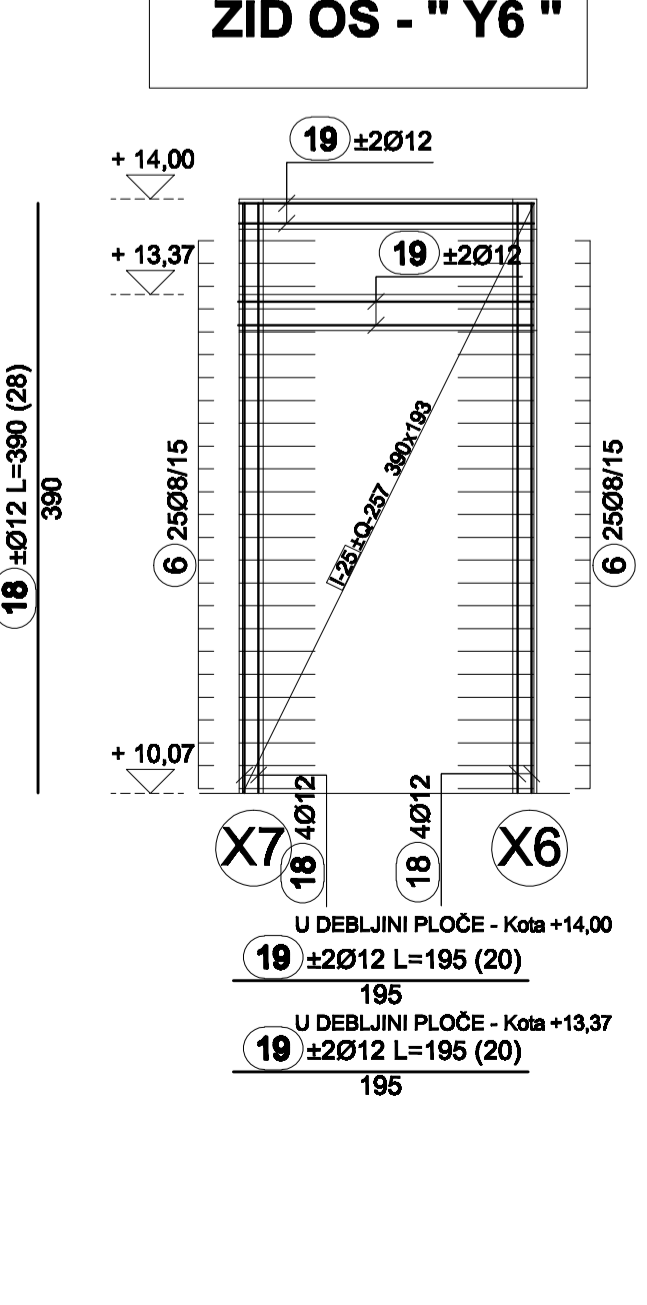
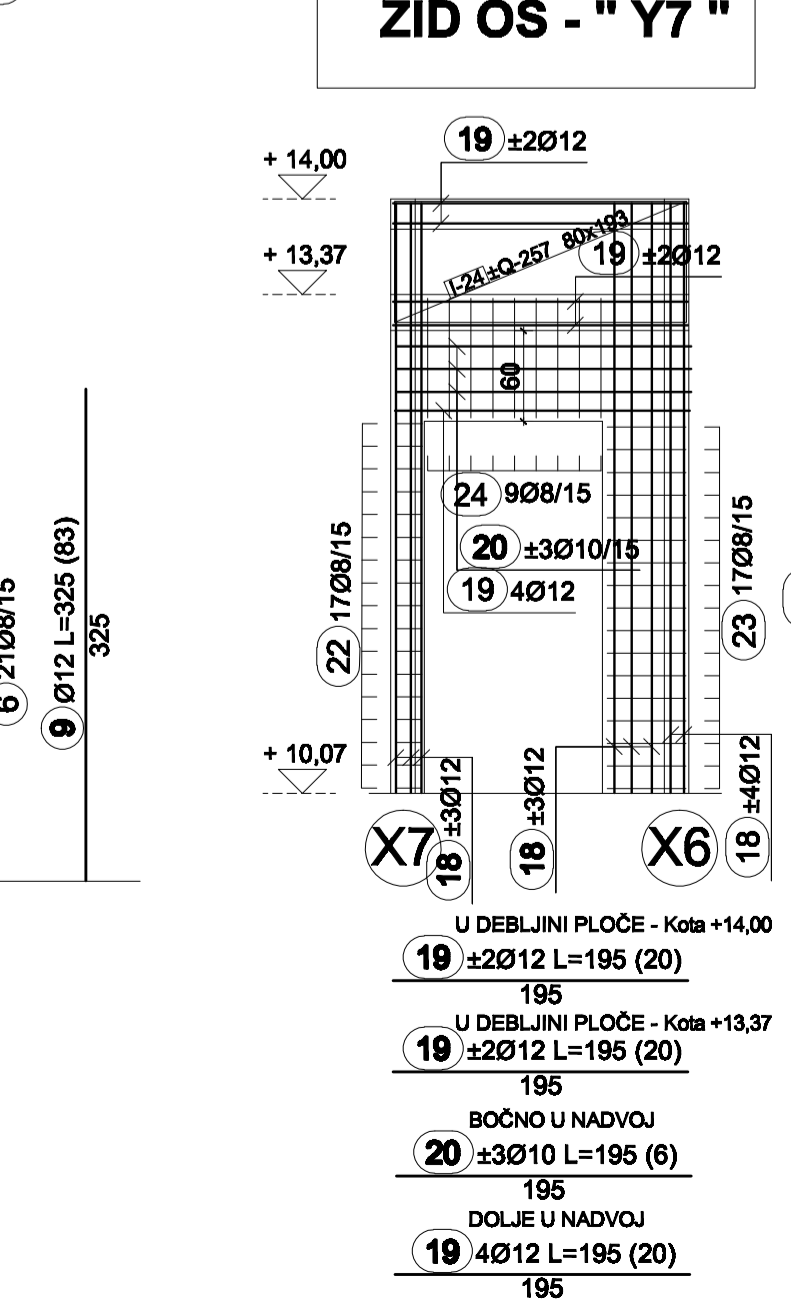
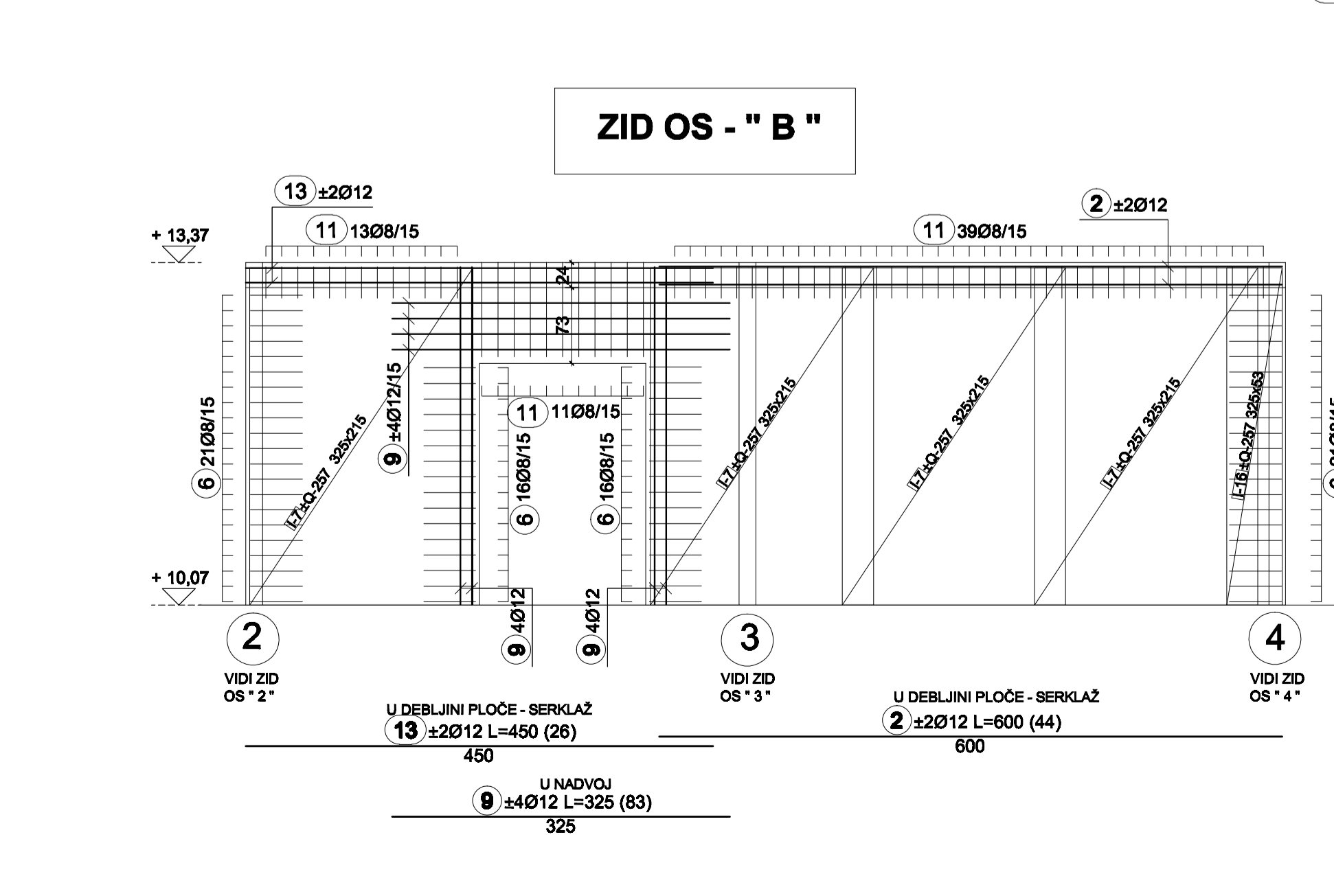
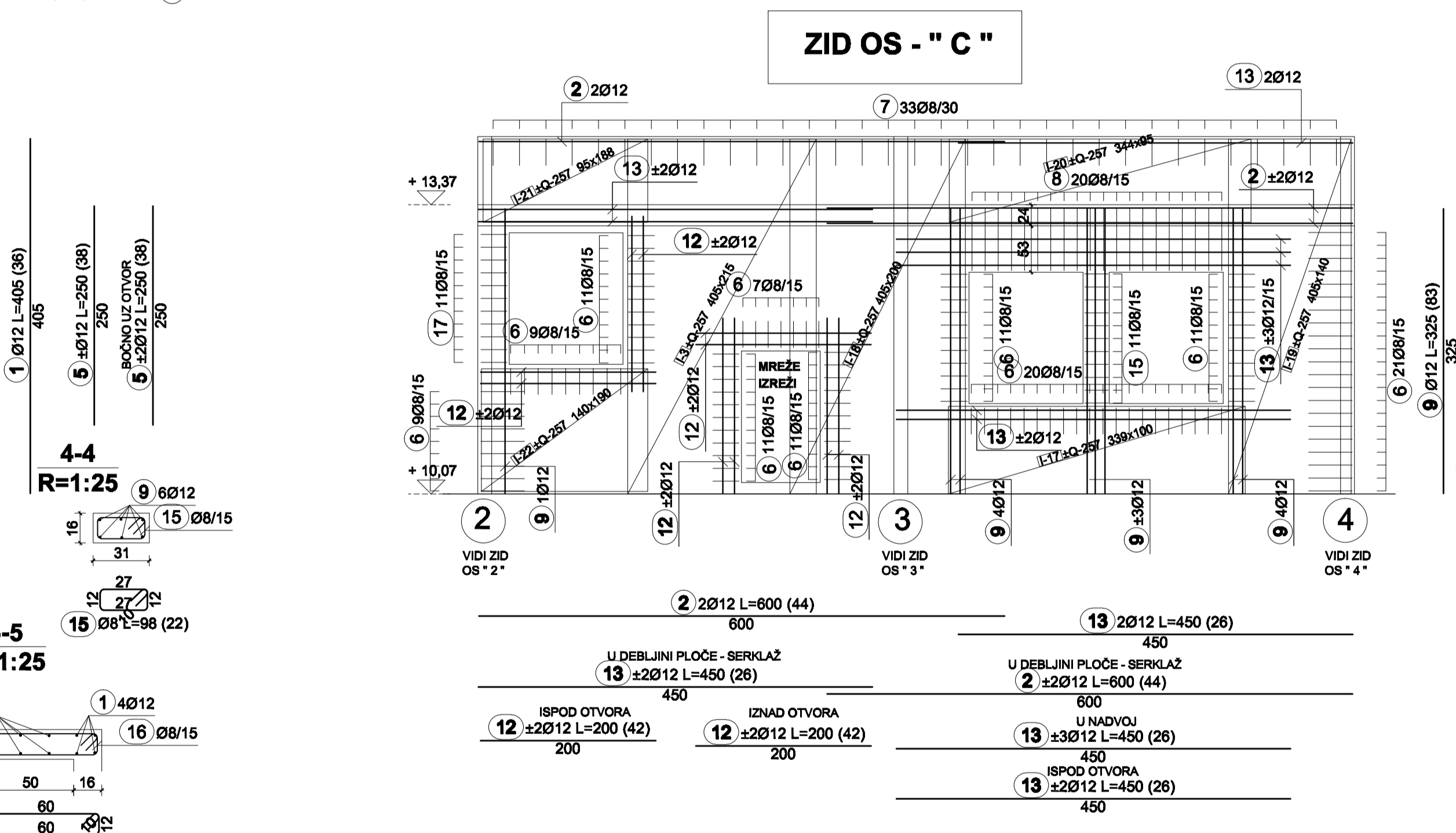
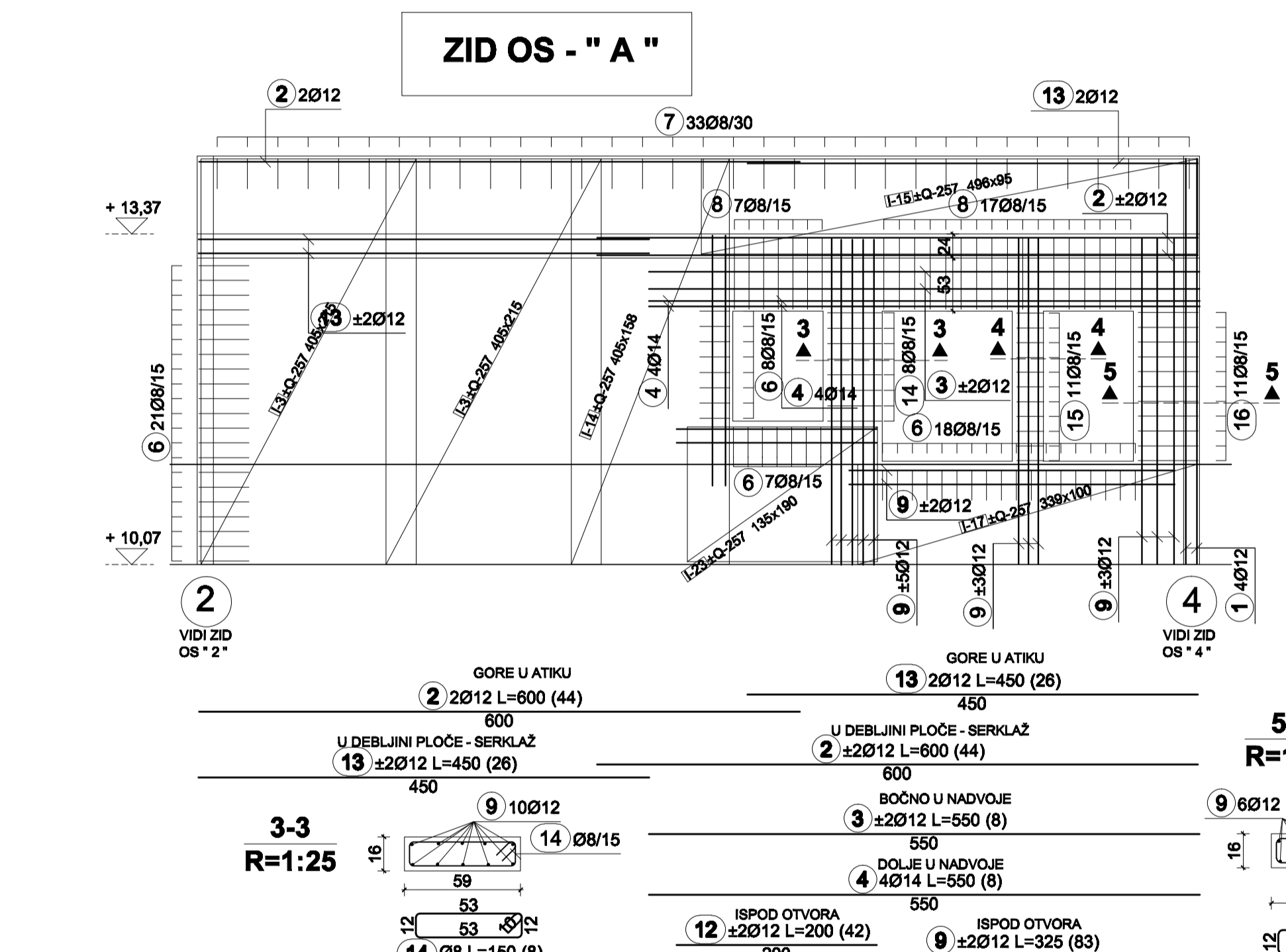
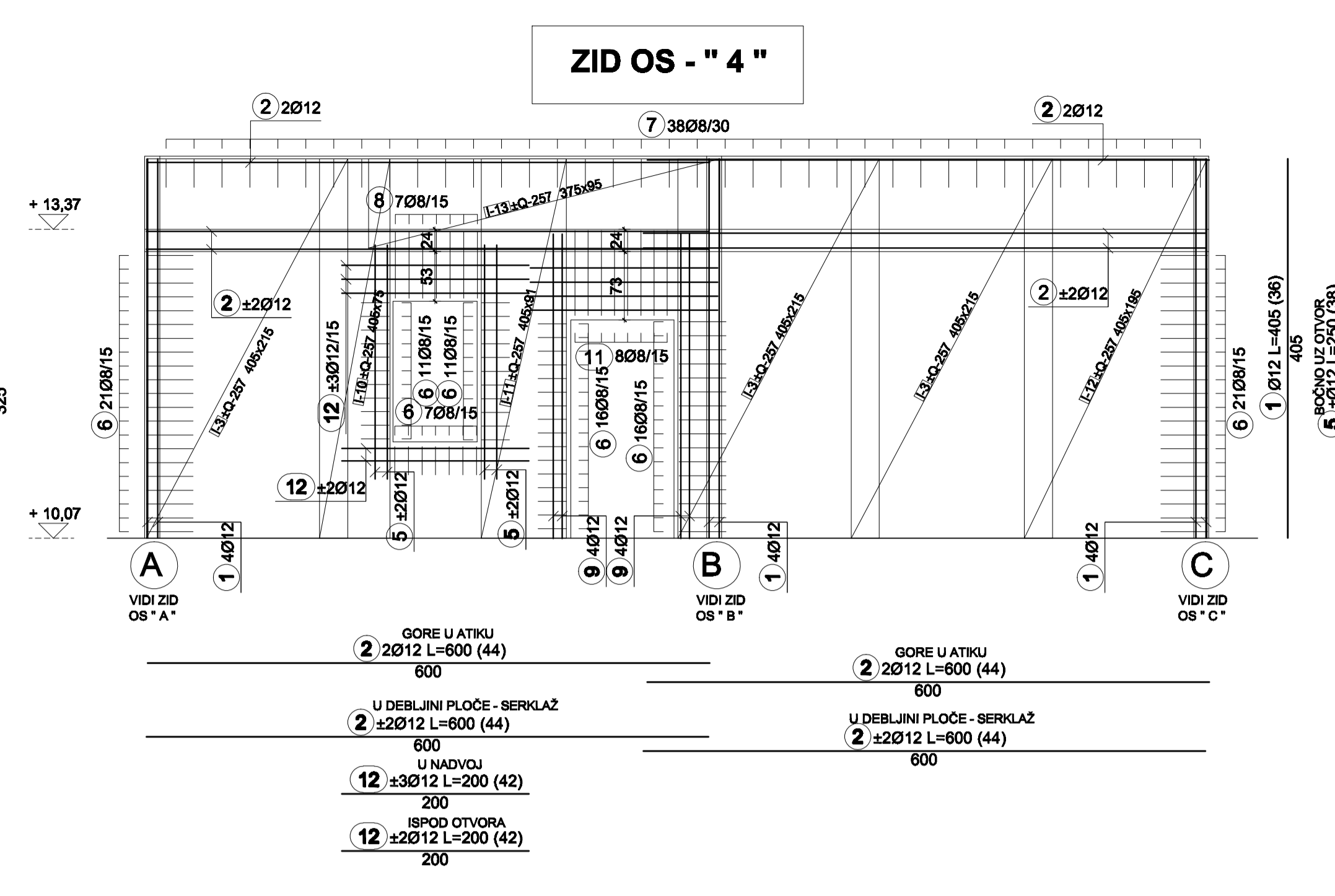
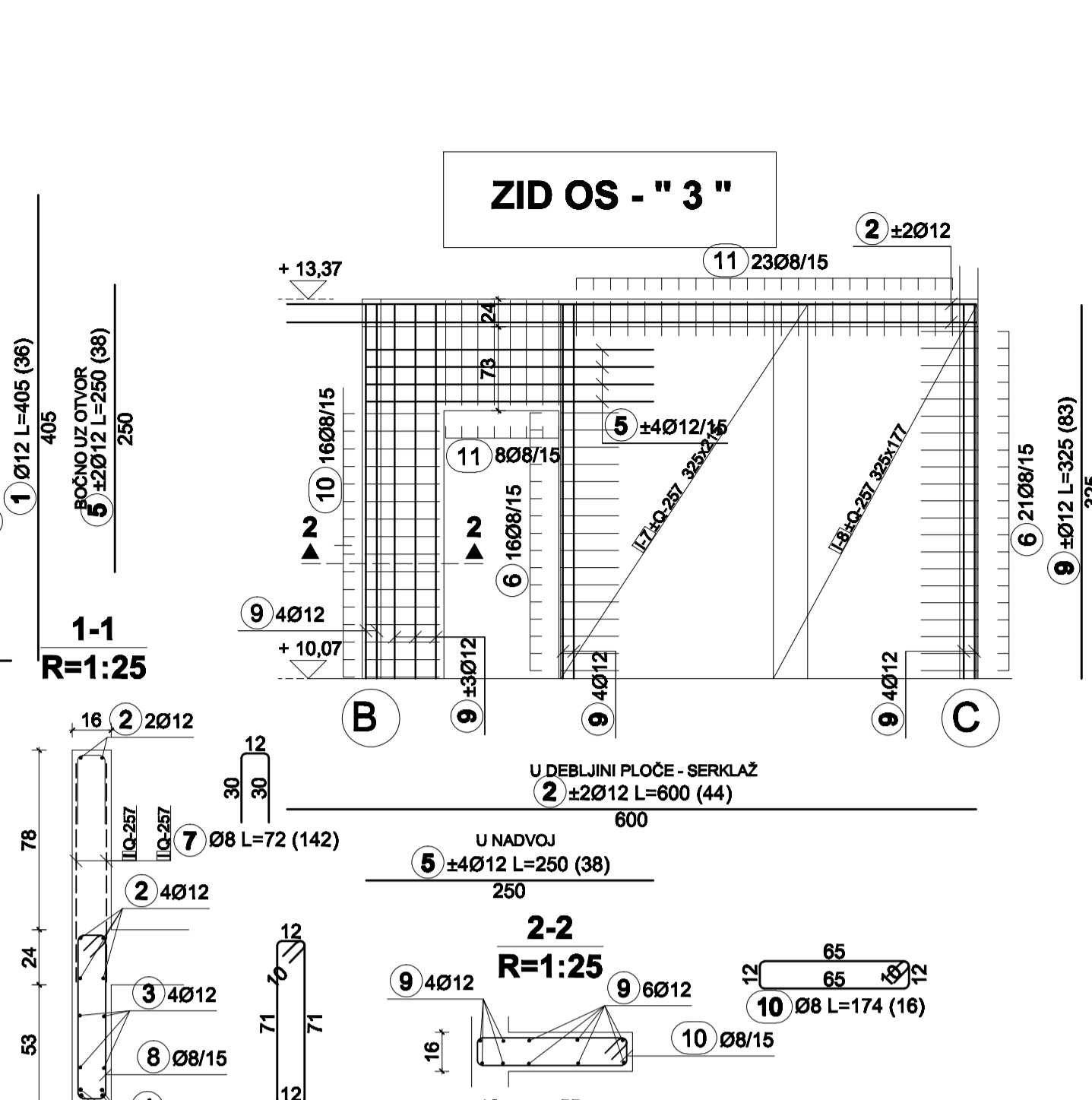
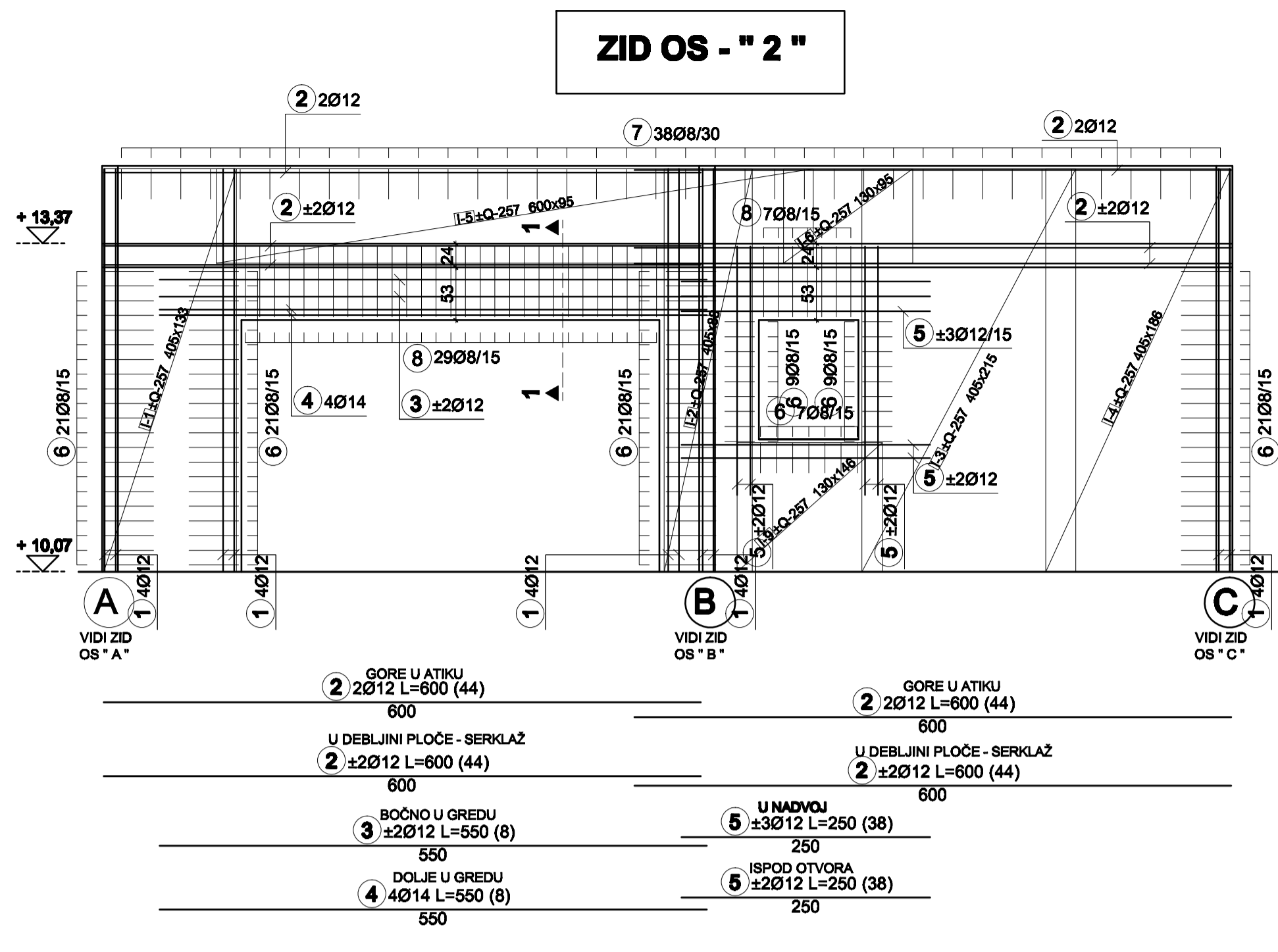

Spisak - specifikacija

com	oznaka	opis	Ø	l	n	lgn
1	Ø20/12	400	12	4.00	36	140.00
2	Ø20/12	600	12	6.00	44	264.00
3	Ø20/12	500	12	5.00	8	41.00
4	Ø20/12	550	14	5.50	8	44.00
5	Ø20/12	350	12	3.50	38	98.00
6	Ø20/12	400	8	1.12	698	660.78
7	Ø20/12	30	8	0.72	142	102.24
8	Ø20/12	71	8	1.86	87	161.82
9	Ø20/12	250	12	3.25	83	269.75
10	Ø20/12	50	8	1.74	16	27.84
11	Ø20/12	91	8	2.26	102	230.52
12	Ø20/12	60	12	2.00	42	84.00
13	Ø20/12	480	12	4.80	26	117.00
14	Ø20/12	50	8	1.50	8	12.00
15	Ø20/12	27	8	0.96	22	21.58
16	Ø20/12	80	8	1.84	11	18.04
17	Ø20/12	30	8	1.04	11	11.44
18	Ø20/12	350	12	3.90	26	109.20
19	Ø20/12	198	12	1.95	20	39.00
20	Ø20/12	198	10	1.95	6	11.70
22	Ø20/12	17	8	0.78	17	13.28
23	Ø20/12	82	8	1.48	17	25.16
24	Ø20/12	79	8	2.10	9	18.90
25	Ø20/12	250	12	2.10	8	16.80

Spisak - rekapitulacija

Ø [mm]	lgn [m]	Jedinična težina [kg/m]	Težina [kg]
8	1312.64	0.40	518.46
10	11.70	0.62	7.28
12	1184.88	0.80	1067.88
14	44.00	1.21	53.24
Ukupno			1690.79

Mreža - rekapitulacija

Dzelište mreže	B [mm]	L [mm]	n	Jedinična težina [kg/m²]	Ukupna težina [kg]
Q-257	215	600	80	4.02	2662.90
Ukupno					2662.90

VILICE IZ VANJSKIH ZIDOVA (GREDA)
U PLOČE - VIDI ARMATURU PLOČA

PREKLOP MREŽA
a = 30 cm

ZAŠTITNI SLOJ BETONA
c = 2,0 cm

BETON C25/30
ARMATURA B500B

3. KAT - ZIDOVI

Br. revizije:	REVIZIJA	Datum revizije:
<p>RADIONICA STATIKE d.o.o. INVESTITOR: HRVATSKI CRVENI KRIZ Ul. Crvenog križa 14-16, 10000 Zagreb OIB: 7262733869</p>		
GLAVNI PROJEKTANT: Sanela Begonović, dipl.ing.arh.	GRAĐEVINA: KORISNIŠKE SOCIJALNIH USLUGA U ZAJEDNICI	ZGRADA CENTRA HRVATSKOG CRVENOG KRIZA U ZAJEDNICI
PROJEKTANT KONSTRUKCIJE: Branislav Galić, dipl.ing.grad.	LOKACIJA: Zagreb, Dubravski trg 11 k.č.br. 277, k.c. Trp.	FAZA PROJEKTA: IZVEDBENI GRAĐEVINSKI PROJEKT
SURADNICI: Vlaho Mijenić, mag.ing.aedif. Toma Čurković, mag.ing.aedif. Lara Antunović-Fantulin, mag.ing.aedif.	SADRŽAJ: 3. KAT - ZIDOVI	MJERILO: 1:50 BR.NACRTA: 12
Datum: 02/2021		

DONJA ZONA

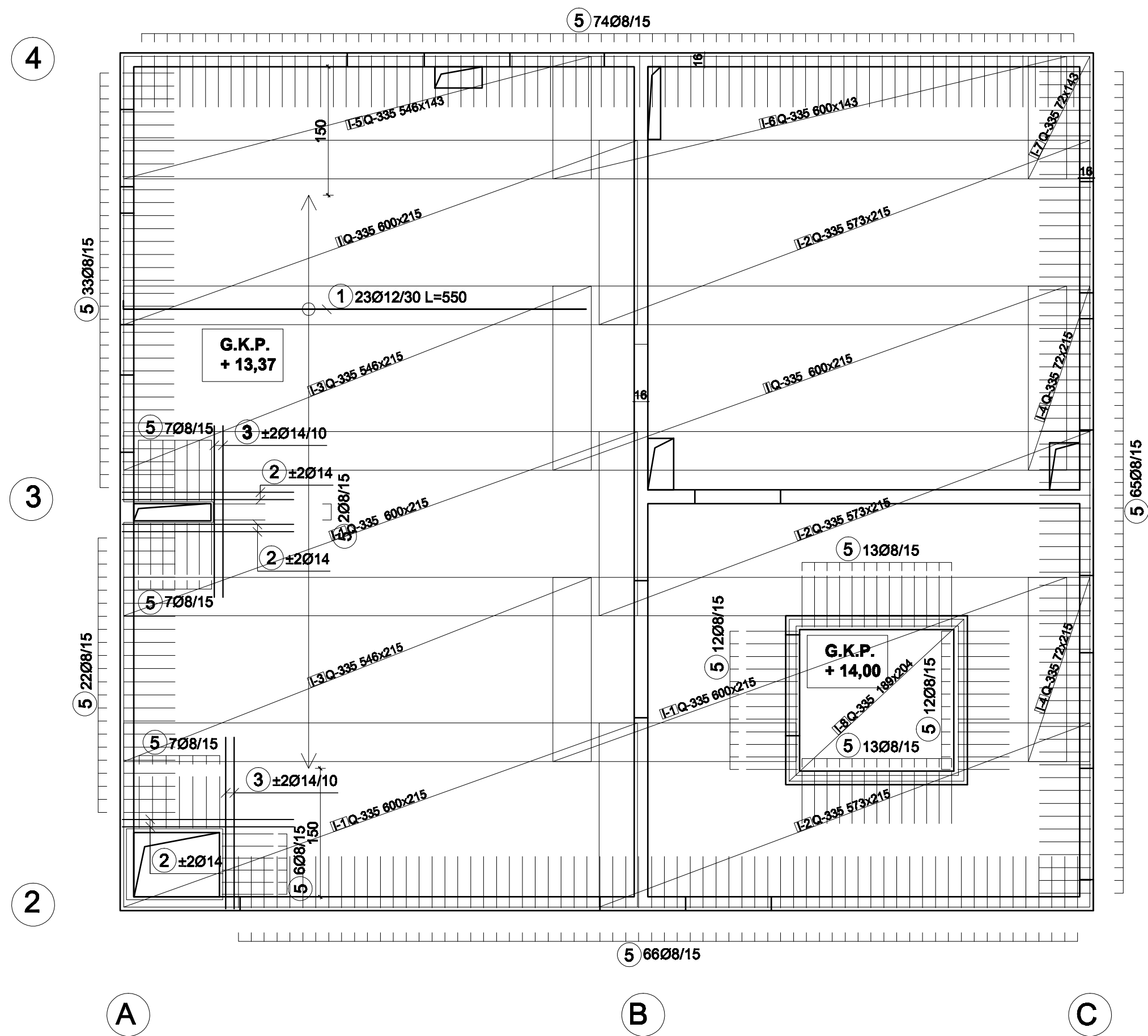

GORNJA ZONA

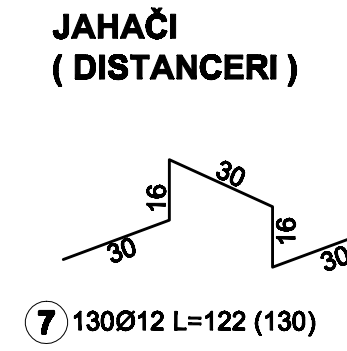
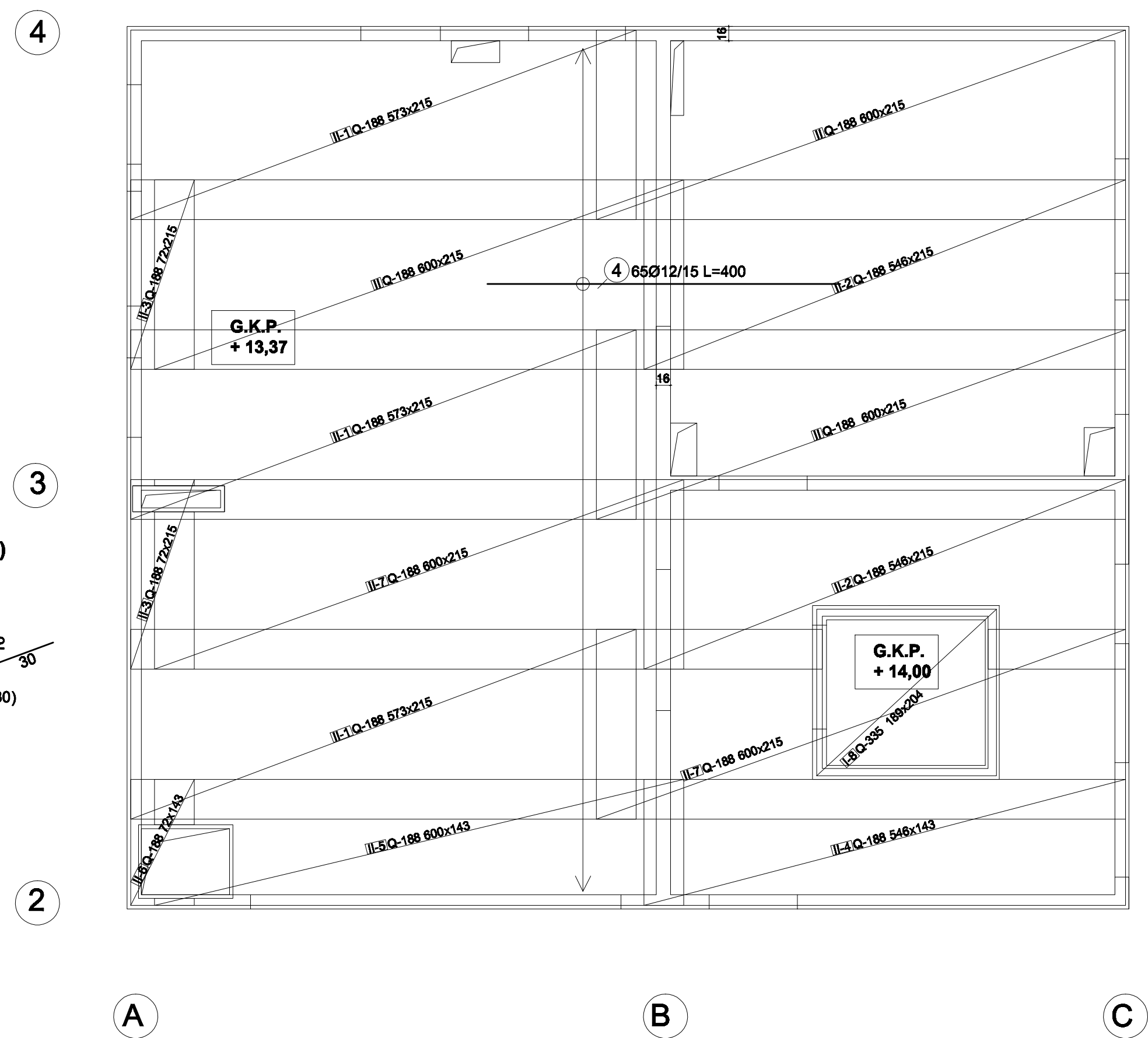

Šipke - specifikacija

ozn	oblik i mjera [cm]	Ø	lg [m]	n [kom]	lgn [m]
nomena (1 kom)					
1	640	12	6.50	23	126.90
2	200	14	2.20	12	26.40
3	200	14	2.00	8	16.00
4	400	12	4.00	65	260.00
5	80	8	1.38	339	461.04
6	600	12	6.00	5	30.00
7	30 16 30 27 12 28 10 30 28 10	12	1.22	130	158.60

Šipke - rekapitulacija

Ø [mm]	lgn [m]	Jedinična težina [kg/m]	Težina [kg]
S 500			
8	461.04	0.40	182.11
12	675.10	0.89	610.89
14	42.40	1.21	51.30
Ukupno			744.10

Mreže - rekapitulacija

Oznaka mreže	B [cm]	L [cm]	n	Jedinična težina [kg/m²]	Ukupna težina [kg]
Q-335	215	600	13	5.26	882.10
Q-188	215	600	12	2.96	458.21
Ukupno					1340.31

3. KAT ARMATURA PLOČE

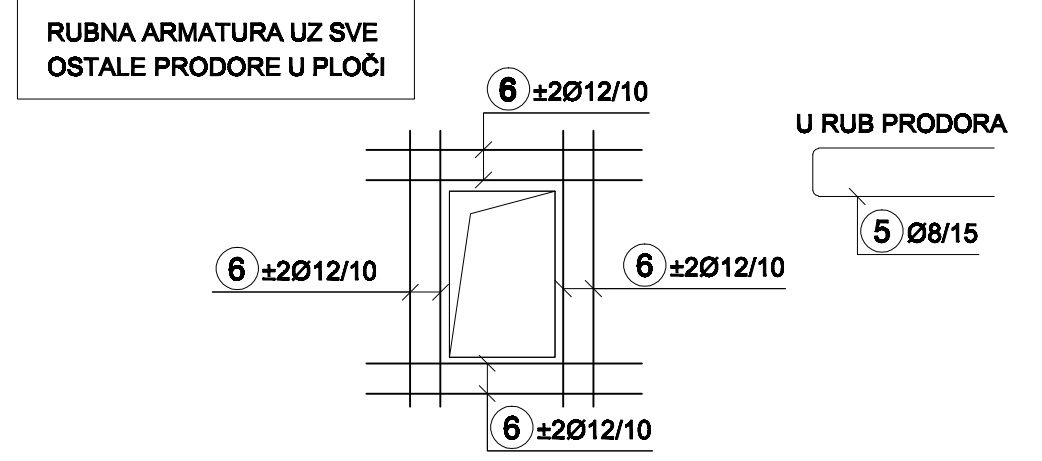

- ARMATURU HORIZONTALNIH SERKLAŽA - VIDI NACRT - 3. KAT - ARMATURA ZIDOVA, (ako nije drugačije naznačeno).

PREKLOP MREŽA
a =45 cm

ZAŠTITNI SLOJ BETONA
c=2,5 cm

BETON C25/30
ARMATURA B500B

Br. revizije:	REVIZIJA	Datum revizije:
RADIONICA STATIKE d.o.o. Avdije Kačića Mirošića 22, 10 000 Zagreb tel: +385 (1) 30 50 444 fax: +385 (1) 30 50 445 e-mail: radionica@statika.hr		
GLAVNI PROJEKTANT: Sanela Beganović, dipl.ing.arh. PROJEKTANT KONSTRUKCIJE: Branko Galčić, dipl.ing.grad.	GRAĐEVINA: ZGRADA CENTRA HRVATSKOG CRVENOG KRIŽA U KORISNIKESOCIJALNIH USLUGA U ZAJEDNICI LOKACIJA: Zagreb, Dubravčin trg 11 k.č.br: 277, k.o. Trnje FAZA PROJEKTA: IZVEDBENI GRAĐEVINSKI PROJEKT	INVESTITOR: HRVATSKI CRVENI KRIŽ Ulica Crvenog križa 14-16, 10000 Zagreb OIB: 72627253859 SADRŽAJ: 3. KAT PLOČE
SURADNICI: Vlaho Mijanović, mag.ing.aedif. Tomo Čurković, mag.ing.aedif. Lara Antulov-Fentulin, mag.ing.aedif.	MJEILO: 1:50 BR.PR.:TD 135/2020	DATUM: 02/2021 BR.NACRTA: 13

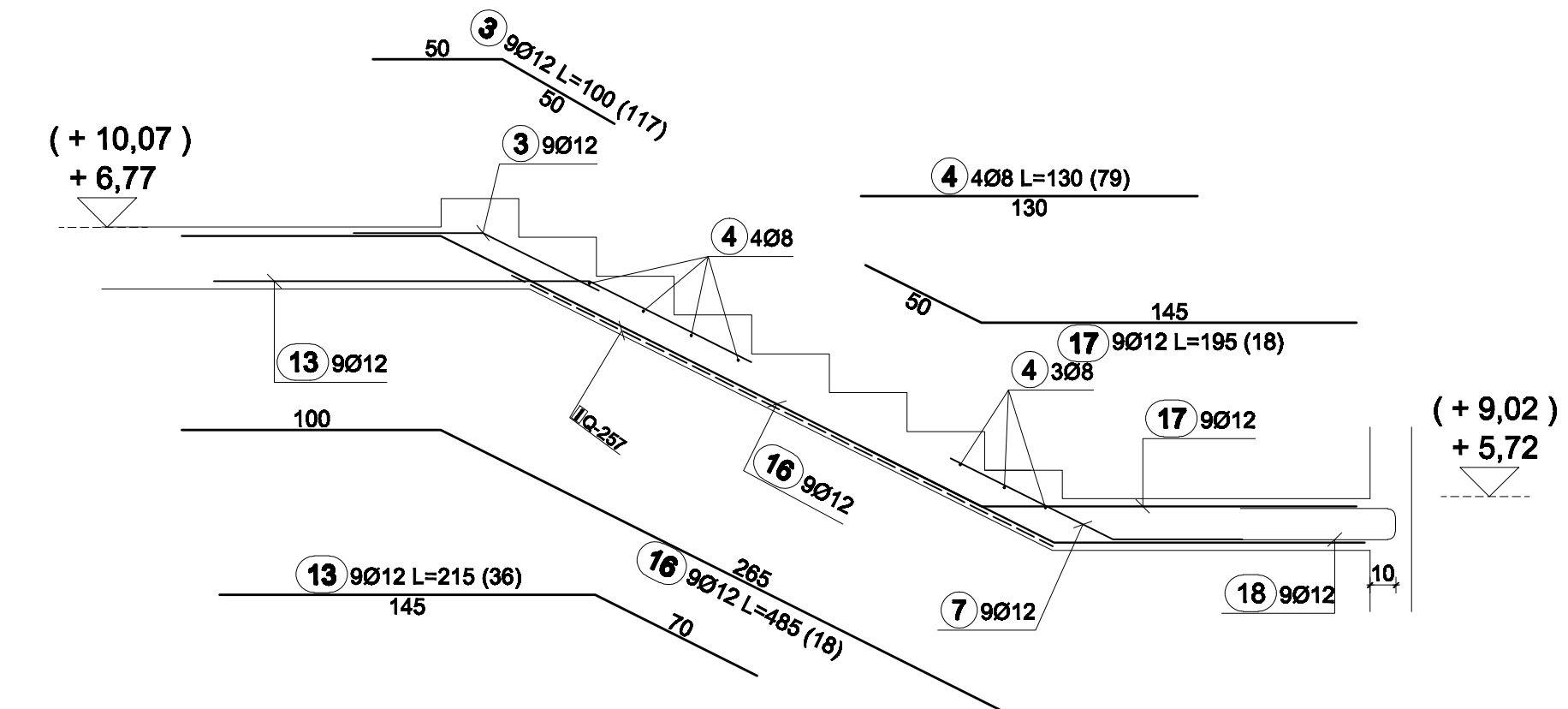
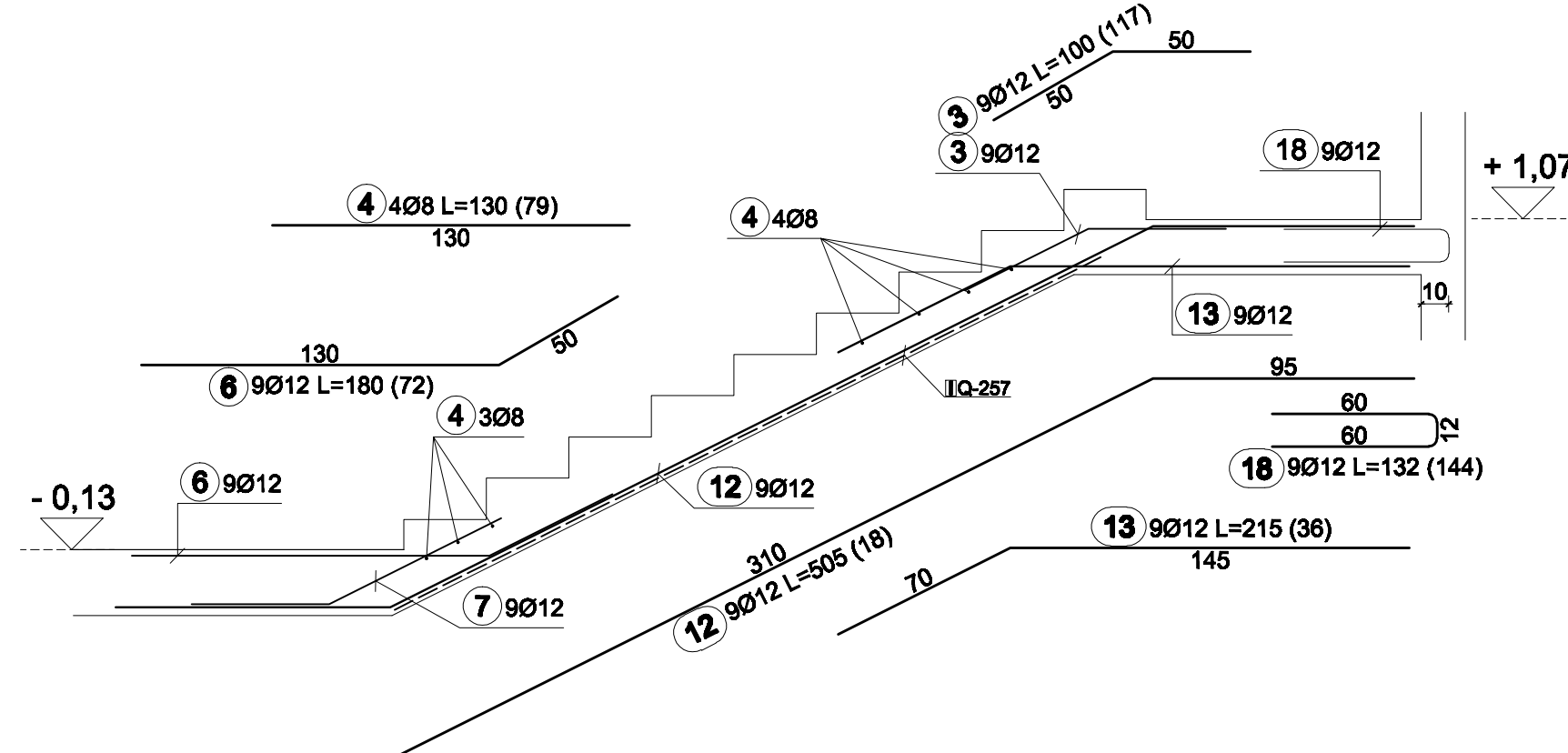
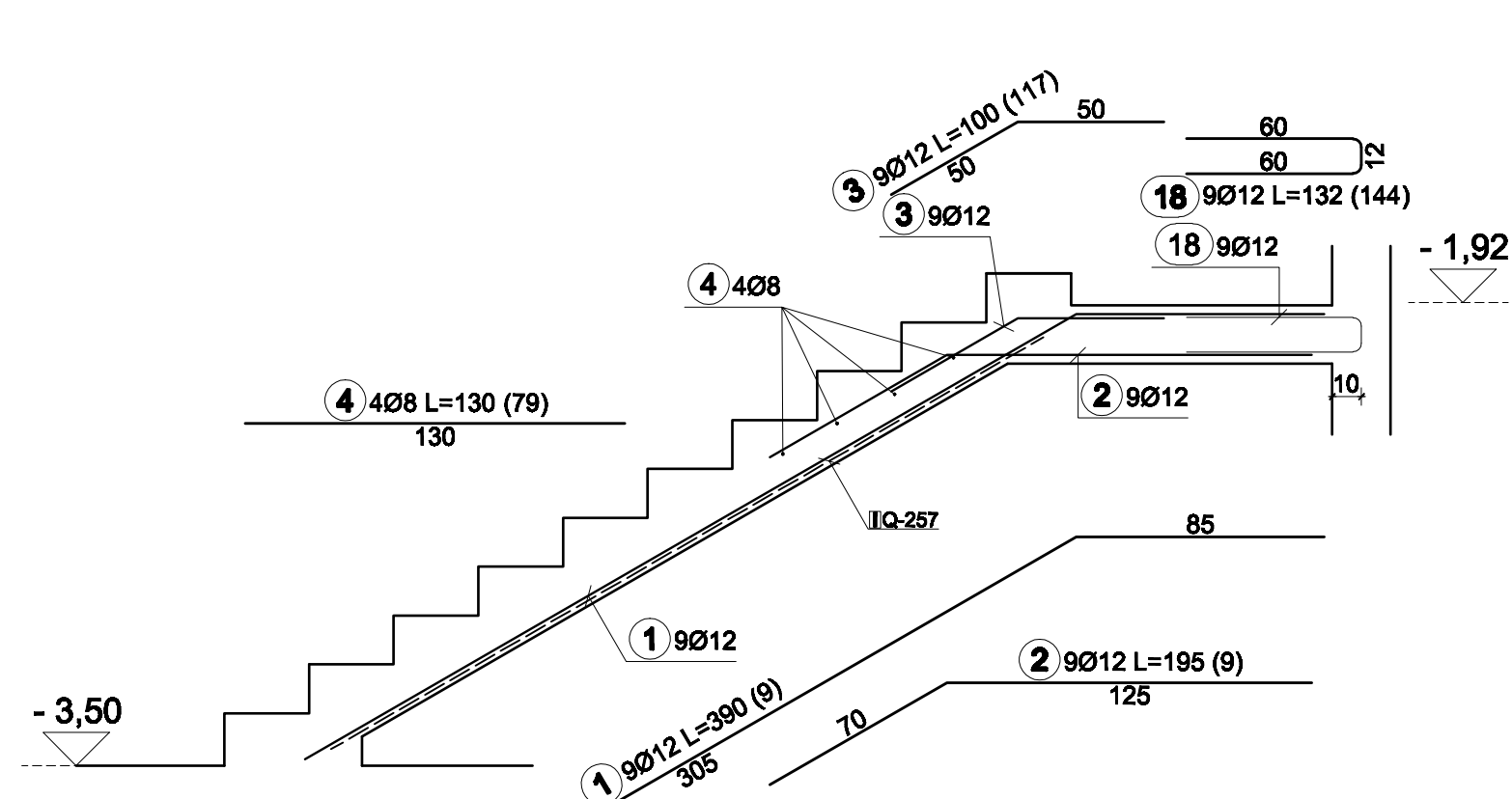

60
60
18 Ø12 L=132 (144)
IZ ZIDOVA OS - 2; 3; i C,
prije betoniranja zidova,
ostaviti nastavke u podeste.

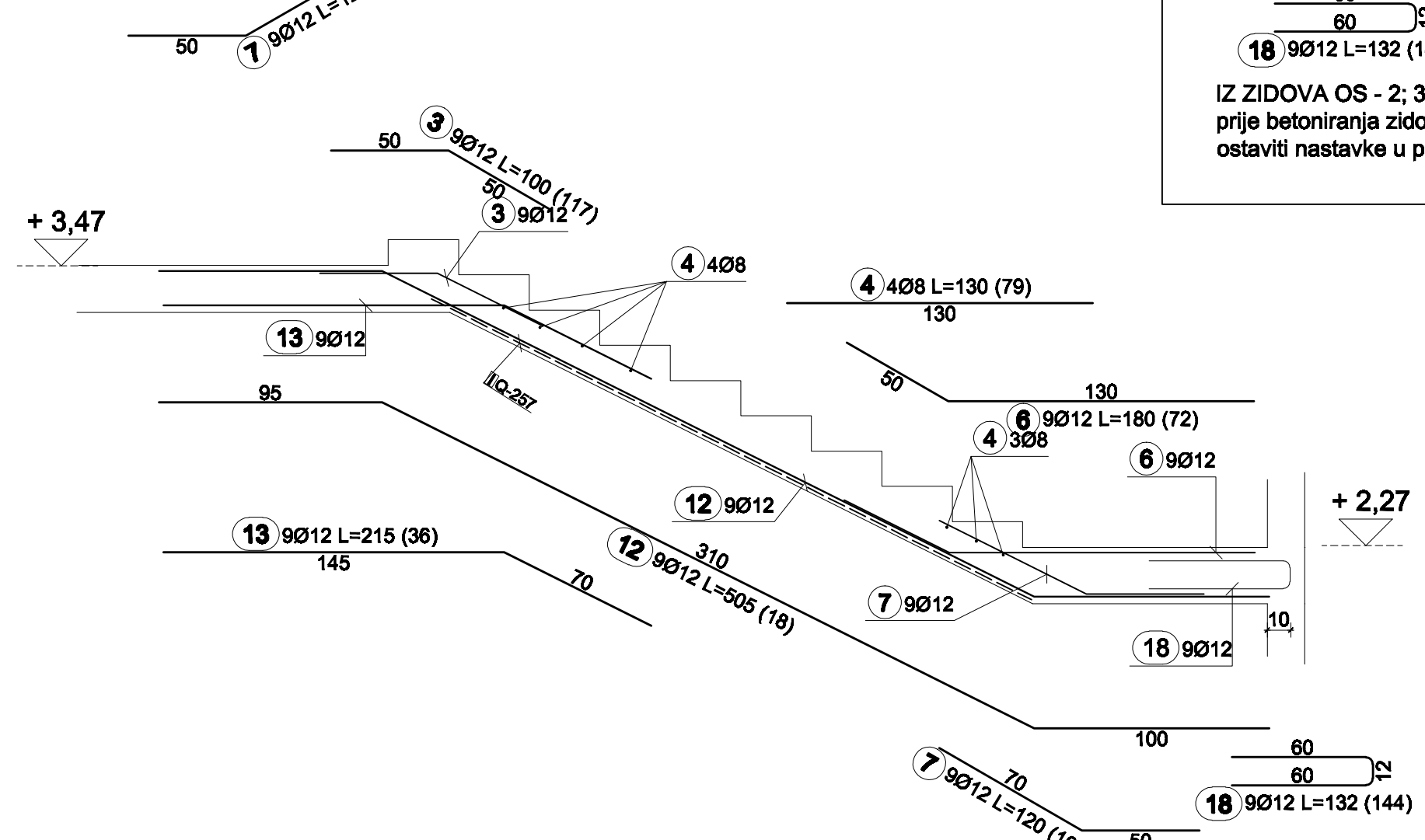
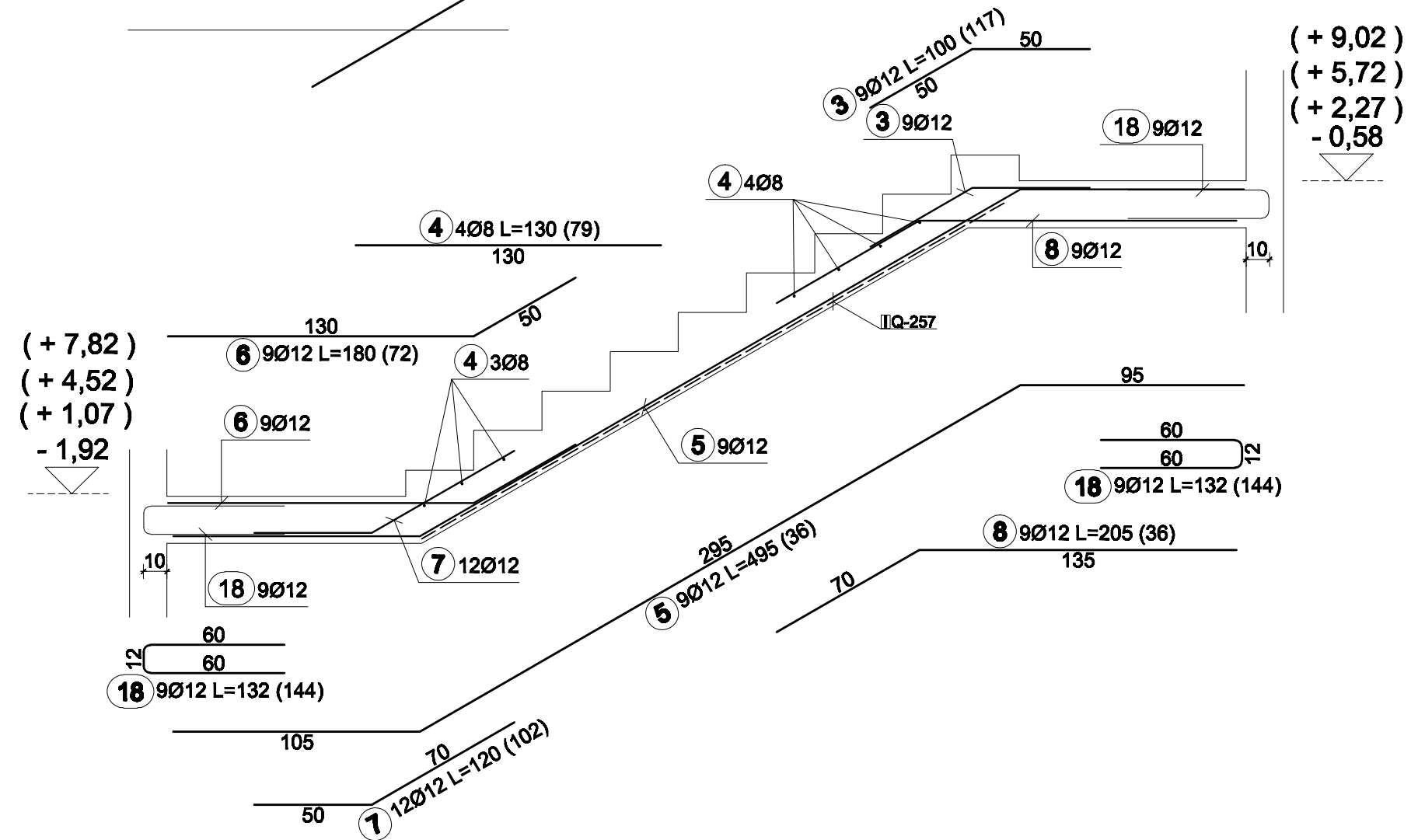

Ø [mm]	lgn [m]	Jedinična težina [kg/m]	Težina [kg]
8	102,70	0,40	40,57
12	1372,23	0,86	1218,54
Ukupno			1259,11

Oznaka mreže	B [cm]	L [cm]	n	Jedinična težina [kg/m ²]	Ukupna težina [kg]
O-257	215	600	5	4,02	259,29
Ukupno					259,29

ozn	oblik i mjera [cm]	Ø	lgn [m]	n [kom]	lgn [m]
1		12	3,90	9	35,10
2		12	1,85	9	17,55
3		12	1,00	117	117,00
4		8	1,30	79	102,70
5		12	4,85	36	178,20
6		12	1,80	72	129,60
7		12	1,20	102	122,40
8		12	2,05	36	73,80
9		12	4,70	9	42,30
10		12	3,15	9	28,35
11		12	2,05	9	18,45
12		12	0,05	18	0,90
13		12	2,15	36	77,40
14		12	4,85	18	87,30
15		12	2,30	18	41,40

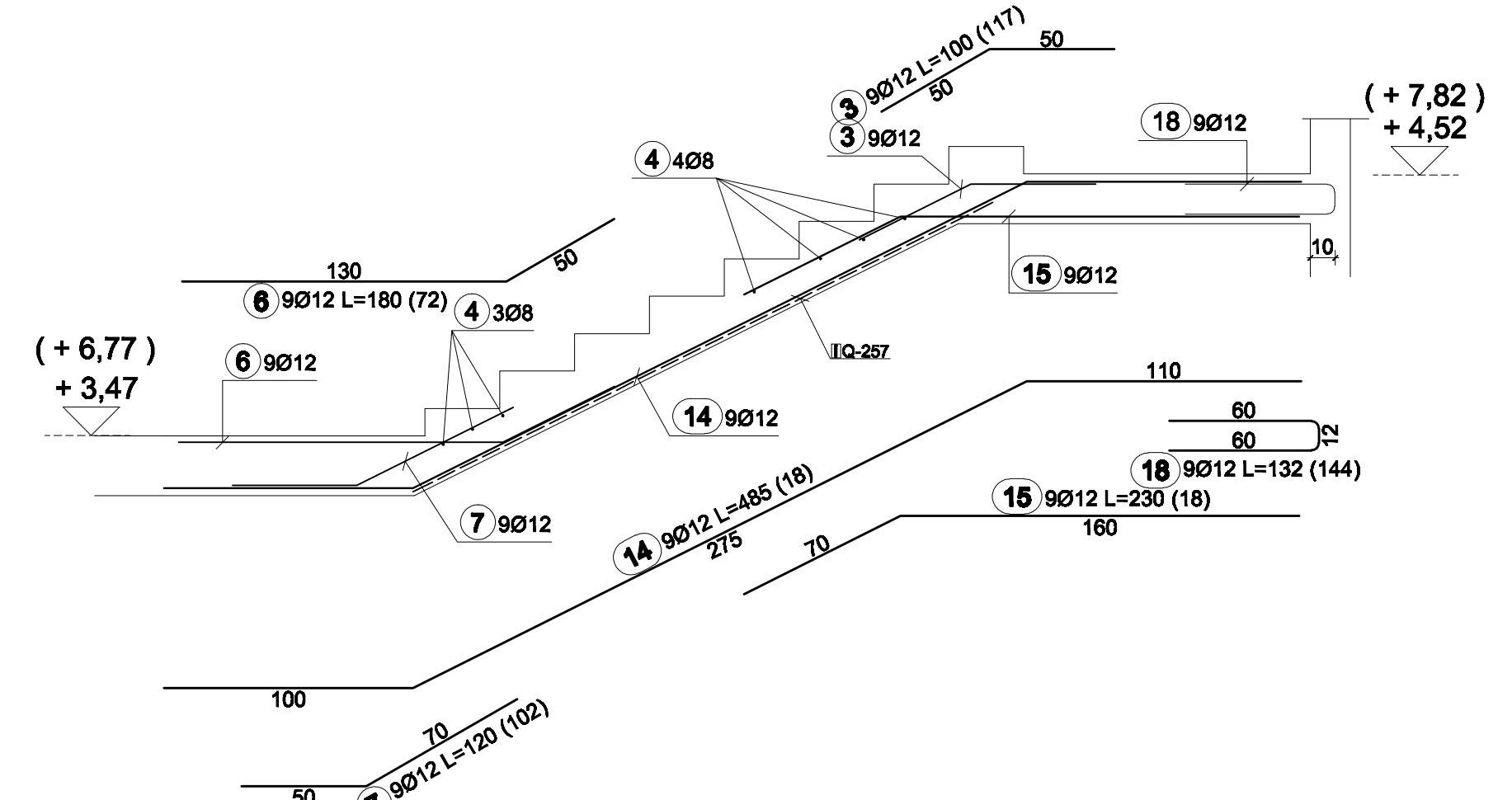
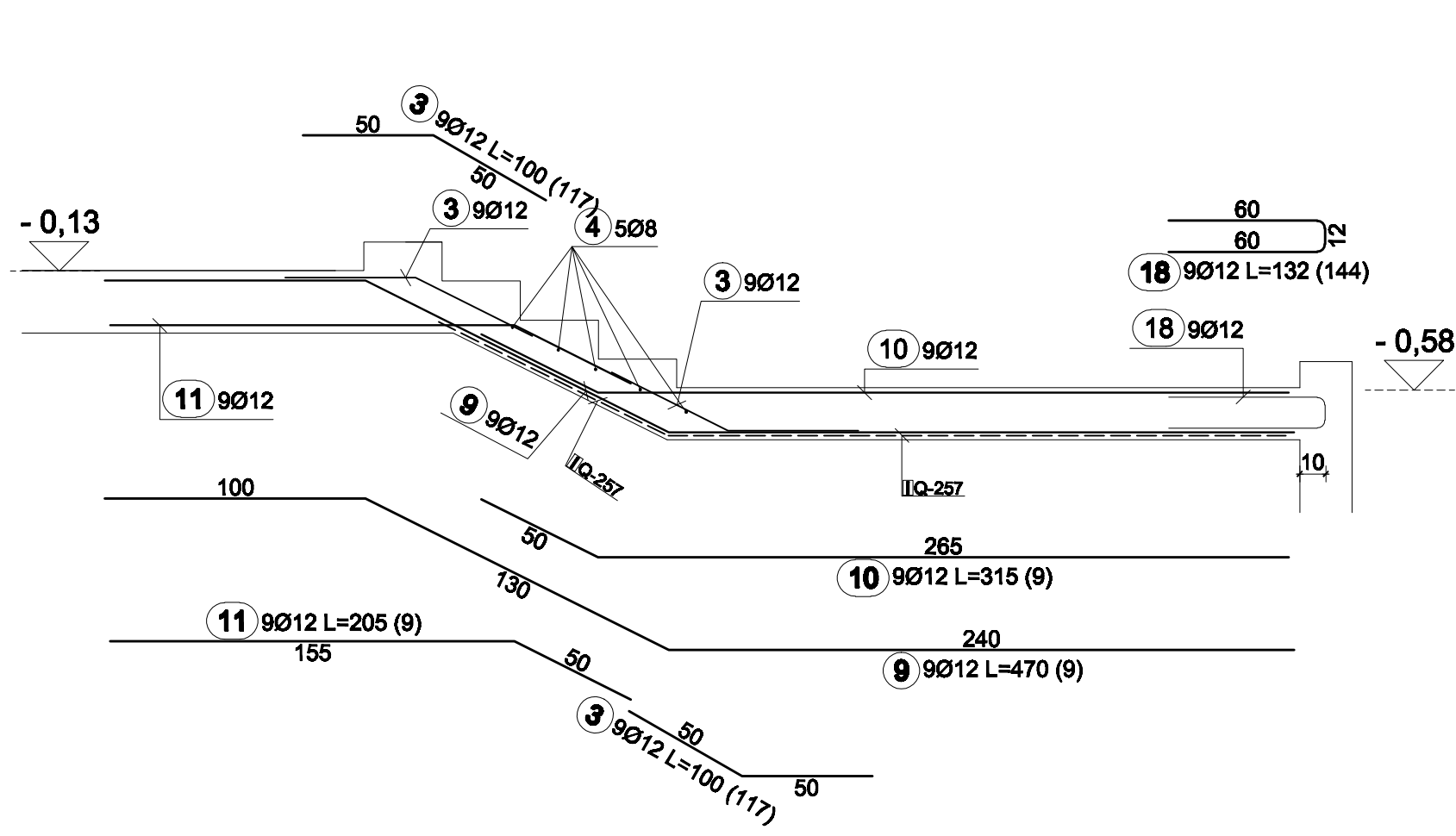

ZAŠITNI SLOJ BETONA
c=2,5 cm

BETON C25/30
ARMATURA B500B

STEPENICE

Br. revizije:	REVIZIJA	Datum revizije:
RADIONICA STATIKE d.o.o. HRVATSKI CRVENI KRIZ Ulica Crvenog križa 14-16, 10000 Zagreb OIB: 72527263659		
GLAVNI PROJEKTANT:	Sanela Beganović, dipl.ing.arh.	INVESTITOR:
PROJEKTANT KONSTRUKCIJE:	Branko Galčić, dipl.ing.grad.	GRAĐEVINA:
SURADNICI:	Vlaško Miljanović, mag.ing.aedif. Toma Čurković, mag.ing.aedif. Lara Antulov-Fantulin, mag.ing.aedif.	ZGRADA CENTRA HRVATSKOG CRVENOG KRIŽA U KORISNIKESOCIJALNIH USLUGA U ZAJEDNICI Lokacija: Zagreb, Dubravkin trg 11 K.o.Br: 277, k.o. Trnje FAZA PROJEKTA: IZVEDBENI GRAĐEVINSKI PROJEKT SDRŽAJ: STEPENICE MJERILO: 1:50 DATUM: 02/2021 BR.PR.:TD 135/2020 BR.NACRTA: 14